

Installation and Operating Guide | Warranty

Model Number | XBS245 | DVD/VCR/Radio Combination Home Theater System



Safety Precautions



CAUTION
RISK OF ELECTRIC SHOCK
DO NOT OPEN



CAUTION: TO REDUCE THE RISK OF ELECTRIC SHOCK DO NOT REMOVE COVER (OR BACK) NO USER-SERVICEABLE PARTS INSIDE REFER SERVICING TO QUALIFIED SERVICE PERSONNEL.



This lightning flash with arrowhead symbol within an equilateral triangle is intended to alert the user to the presence of uninsulated dangerous voltage within the product's enclosure that may be of sufficient magnitude to constitute a risk of electric shock to persons.



The exclamation point within an equilateral triangle is intended to alert the user to the presence of important operating and maintenance (servicing) instructions in the literature accompanying the product.

WARNING: TO REDUCE THE RISK OF FIRE OR ELECTRIC SHOCK, DO NOT EXPOSE THIS APPARATUS TO RAIN OR MOISTURE.

CAUTION: TO PREVENT ELECTRIC SHOCK, MATCH WIDE BLADE OF PLUG TO WIDE SLOT, FULLY INSERT.

ATTENTION: POUR ÉVITER LES CHOC ÉLECTRIQUES, INTRODUIRE LA LAME LA PLUS LARGE DE LA FICHE DANS LA BORNE CORRESPONDANTE DE LA PRISE ET POUSSER JUSQU'AU FOND.

WARNING: Do not install this equipment in a confined space such as a bookcase or similar unit.

NOTE TO CABLE/TV INSTALLER: This reminder is provided to call the cable TV system installer's attention to Article 820-40 of the National Electric Code (U.S.A.). The code provides guidelines for proper grounding and, in particular, specifies that the cable ground shall be connected to the grounding system of the building, as close to the point of the cable entry as practical.

CAUTION:

This DVD+VCR employs a Laser System.

To ensure proper use of this product, please read this owner's manual carefully and retain for future reference. Should the unit require maintenance, contact an authorized service location.

Use of controls, adjustments, or the performance of procedures other than those specified herein may result in hazardous radiation exposure.

To prevent direct exposure to laser beam, do not try to open the enclosure. Visible laser radiation when open. **DO NOT STARE INTO BEAM.**

CAUTION: The apparatus should not be exposed to water (dripping or splashing) and no objects filled with liquids, such as vases, should be placed on the apparatus.

FCC WARNING: This equipment may generate or use radio frequency energy. Changes or modifications to this equipment may cause harmful interference unless the modifications are expressly approved in the instruction manual. The user could lose the authority to operate this equipment if an unauthorized change or modification is made.

REGULATORY INFORMATION: FCC Part 15

This product has been tested and found to comply with the limits for a Class B digital device, pursuant to Part 15 of the FCC Rules. These limits are designed to provide reasonable protection against harmful interference when the product is operated in a residential installation. This product generates, uses, and can radiate radio frequency energy and, if not installed and used in accordance with the instruction manual, may cause harmful interference to radio communications. However, there is no guarantee that interference will not occur in a particular installation. If this product does cause harmful interference to radio or television reception, which can be determined by turning the product off and on, the user is encouraged to try to correct the interference by one or more of the following measures:

- Reorient or relocate the receiving antenna.
- Increase the separation between the product and receiver.
- Connect the product into an outlet on a circuit different from that to which the receiver is connected.
- Consult the dealer or an experienced radio/TV technician for help.

FCC COMPLIANCE: The responsible party for this product's compliance is: Zenith Electronics Corporation, 2000 Millbrook Drive, Lincolnshire, IL 60069, USA.
Phone: 1-847-941-8000



NOTES ON COPYRIGHTS:

It is forbidden by law to copy, broadcast, show, broadcast via cable, play in public, or rent copyrighted material without permission.

This product features the copy protection function developed by Macrovision. Copy protection signals are recorded on some discs. When recording and playing the pictures of these discs on a VCR, picture noise will appear.

This product incorporates copyright protection technology that is protected by method claims of certain U.S. patents and other intellectual property rights owned by Macrovision Corporation and other rights owners. Use of this copyright protection technology must be authorized by Macrovision Corporation, and is intended for home and other limited viewing uses only unless otherwise authorized by Macrovision Corporation. Reverse engineering or disassembly is prohibited.

SERIAL NUMBER: The serial number is found on the back of this unit. This number is unique to this unit and not available to others. You should record requested information here and retain this guide as a permanent record of your purchase.

Model No. _____

Serial No. _____

IMPORTANT SAFETY INSTRUCTIONS

CAUTION: PLEASE READ AND OBSERVE ALL WARNINGS AND INSTRUCTIONS IN THIS OWNER'S MANUAL, AND THOSE MARKED ON THE PRODUCT. RETAIN THIS BOOKLET FOR FUTURE REFERENCE.

This product has been designed and manufactured to assure personal safety. Improper use can result in electric shock or fire hazard. The safeguards incorporated in this product will protect you if you observe the following procedures for installation, use, and servicing.



This product does not contain any parts that can be repaired by the user.

DO NOT REMOVE THE CABINET COVER, OR YOU MAY BE EXPOSED TO DANGEROUS VOLTAGE. REFER SERVICING TO QUALIFIED SERVICE PERSONNEL ONLY.

- 1. Read these instructions.** - All these safety and operating instructions should be read before the product is operated.
- 2. Keep these instructions.** - The safety, operating and use instructions should be retained for future reference.
- 3. Heed all warnings.** - All warnings on the product and in the operating instructions should be adhered to.
- 4. Follow all instructions.** - All operating and use instructions should be followed.
- 5. Do not use this product near water.** - For example: near a bath tub, wash bowl, kitchen sink, laundry tub, in a wet basement; or near a swimming pool; and other areas located near water.
- 6. Clean only with dry cloth.** - Unplug this product from the wall outlet before cleaning. Do not use liquid cleaners.
- 7. Do not block any ventilation openings. Install in accordance with the manufacturer's instructions.** - Slots and openings in the cabinet are provided for ventilation and to ensure reliable operation of the product and to protect it from over-heating. The openings should never be blocked by placing the product on a bed, sofa, rug or other similar surface. This product should not be placed in a built-in installation such as a bookcase or rack unless proper ventilation is provided or the manufacturer's instructions have been adhered to.
- 8. Do not install near any heat sources such as radiators, heat registers, stoves, or other apparatus (including amplifiers) that produce heat.**
- 9. Do not defeat the safety purpose of the polarized or grounding-type plug.** A polarized plug has two blades with one wider than the other. A grounding type plug has two blades and a third grounding prong. The wide blade or the third prong are provided for your safety. If the provided plug does not fit into your outlet, consult an electrician for replacement of the obsolete outlet.
- 10. Protect the power cord from being walked on or pinched particularly at plugs, convenience receptacles, and the point where they exit from the product.**
- 11. Only use attachments/accessories specified by the manufacturer.**
- 12. Use only with the cart, stand, tripod, bracket, or table specified by the manufacturer, or sold with apparatus. When a cart is used, use caution when moving the cart/product combination to avoid injury from tip-over.**
- 13. Unplug this product during lightning storms or when unused for long periods of time.**
- 14. Refer all servicing to qualified service personnel. Servicing is required when the product has been damaged in any way, such as power-supply cord or plug is damaged, liquid has been spilled or objects have fallen into the product, the product has been exposed to rain or moisture, does not operate normally, or has been dropped.**



Table of Contents

Introduction	
Safety Precautions	2
IMPORTANT SAFETY INSTRUCTIONS	3
Table of Contents	4
Before Use	5-6
Playable Discs	5
Precautions	6
Notes on Discs	6
About Symbols	6
Front Panel	7
Display Window	8
Remote Control	9
Rear Panel	10
Preparation	
Connections	11-14
Connecting Antenna/Cable TV to a DVD+VCR ..	11
Basic TV Connections	12
Optional TV Connections	12
Speaker System Connections	13
Speaker Positioning	13
Radio Antenna Connections	14
Accessory Audio/Video (A/V) Connections to DVD+VCR	14
Digital Device Connections	14
Selecting the Input/Output Source	15
Before Operation - Sound Mode Descriptions ..	16-18
Mini Glossary for Sound Mode	16
Sound Mode	17
Sound Level	17
Test Tone	17
Delay Time Setting	18
Before Operation - VCR Mode	19-21
On-Screen Display	19
Setting the On-Screen Display	19
Using the VCR Setup Menu	20
Channel Selection	20
Setting the Clock	21
Before Operation - DVD Mode	22-24
General Explanation	22
On-Screen Display	22
Initial Settings	23-24
• <i>Initial Settings General Operation</i>	23
• <i>Language</i>	23
• <i>Picture</i>	23
• <i>Parental Control</i>	24
Operation	
VCR Mode Tape Playback	25-30
Normal Playback	25
Special Effect Playbacks	25
• <i>Search</i>	25
• <i>Still Picture and Frame-by-Frame Playback</i> ..	25
• <i>Slow Motion</i>	25
• <i>CM SKIP (Commercial Skip)</i>	25
VCR Mode Tape Recording	26-28
Normal Recording	26
Timer Recording	26-27
Instant Timer Recording	28
Dubbing and Editing	28
Copying from DVD to VCR	28
VCR Mode Tape Recording Sound Setup	29
VHS Hi-Fi Stereo System/MTS Broadcast	29
VCR Mode Other Features	30
Tape Counter Memory Feature	30
Additional Information	30
DVD Mode Operation	31-33
Playing DVD	31
General Features	31
• <i>Moving to another TITLE</i>	31
• <i>Moving to another CHAPTER</i>	31
• <i>Slow Motion</i>	31
• <i>Still Picture and Frame-by-Frame Playback</i> ..	32
• <i>Search</i>	32
• <i>Random</i>	32
• <i>Repeat</i>	32
• <i>Repeat A-B</i>	32
• <i>Time Search</i>	32
• <i>Zoom</i>	33
• <i>Marker Search</i>	33
Special DVD Features	33
• <i>Checking the contents of DVD Video discs: Menus</i> ..	33
• <i>Title Menu</i>	33
• <i>Disc Menu</i>	33
• <i>Camera Angle</i>	33
• <i>Changing the Audio Language</i>	33
• <i>Subtitle</i>	33
DVD Mode Audio CD Operation	34
Playing Audio CDs and MP3 discs	34
• <i>Pause</i>	34
• <i>Moving to another Track</i>	34
• <i>Repeat Track/ All/ Off</i>	34
• <i>Search</i>	34
• <i>Random</i>	34
• <i>Repeat A-B</i>	34
• <i>Changing the Audio Channel</i>	34
DVD Mode Programmed Playback	35
Programmed Playback with Audio CD and MP3 Discs	35
• <i>Repeat Programmed Tracks</i>	35
• <i>Erasing a Track from Program List</i>	35
• <i>Erasing the Complete Program List</i>	35
DVD Mode Additional Information	36
Screen Saver	36
Video Mode Setting	36
Notes on MP3 Discs	36
Radio Operation	37
Presetting Radio Stations	37
Listening to the Radio	37
Reference	
Troubleshooting	38-40
Language Code List	41
Country Code List	42
Specifications	43-44
Warranty	Rear Cover
About the symbols for instructions	
	Indicates hazards likely to cause harm to the unit itself or other material damage.
	Indicates special operating features of this unit.
	Indicates tips and hints for making the task easier.

Before Use

Playable Discs



DVD
(8 cm/12 cm disc)



Audio CD
(8 cm/12 cm disc)

In addition, this unit can play a CD-R or CD-RW that contains audio titles or MP3 files.

Notes

- Depending on the conditions of the recording equipment or the CD-R/RW disc itself, some CD-R/RW discs cannot be played on the unit.
- The unit cannot play discs that contain data other than MP3 and CD-DA data.
- Do not attach any seal or label to either side (the labeled side or the recorded side) of a disc.
- Do not use irregularly shaped CDs (e.g., heart-shaped or octagonal). It may result in malfunctions.

Notes on DVDs

Some playback operations of DVDs may be intentionally fixed by software manufacturers. As this unit plays DVDs according to disc content designed by the software manufacturer, some playback features of the unit may not be available or other functions may be added. Refer also to the instructions supplied with the DVDs. Some DVDs made for business purposes may not be played on the unit.

Regional code of the DVD+VCR and DVDs

This DVD+VCR is designed and manufactured for playback of Region 1 encoded DVD software. The region code on the labels of some DVD discs indicates which type of DVD+VCR can play those discs. This unit can play only DVD discs labeled 1 or ALL. If you try to play any other discs, the message "Check Regional Code" will appear on the TV screen. Some DVD discs may not have a region code label even though their playback is prohibited by area limits.



Disc-related terms

Title (DVD only)

The main film content or accompanying feature content or music album.

Each title is assigned a title reference number enabling you to locate it easily.

Chapter (DVD only)

Sections of a picture or a musical piece that are smaller than titles. A title is composed of one or several chapters. Each chapter is assigned a chapter number to enable you to locate the chapter you want. Depending on the disc, chapters may not be labeled.

Track (Audio CD only)

Sections of a musical piece on an audio CD. Each track is assigned a track number, enabling you to locate the track you want.

Remote control battery installation

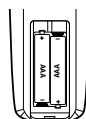

Detach the battery cover on the rear of the remote control, and insert two R03 (size AAA) batteries with \oplus and \ominus matched correctly.

Caution

Do not mix old and new batteries. Never mix different types of batteries (standard, alkaline, etc.).

Remote Control Operation Range

Point the remote control at the remote sensor and press the buttons.

- **Distance:** About 23 ft (7 m) from the front of the remote sensor
- **Angle:** About 30° in each direction of the front of the remote sensor

IMPORTANT NOTE:

SPENT OR DISCHARGED BATTERIES MUST BE RECYCLED OR DISPOSED OF IN A SAFE MANNER IN COMPLIANCE WITH ALL APPLICABLE LAWS. FOR DETAILED INFORMATION, CONTACT YOUR LOCAL COUNTY SOLID WASTE AUTHORITY.

Before Use (Continued)

Precautions

Handling the unit

When shipping the unit

The original shipping carton and packing materials come in handy. For maximum protection, re-pack the unit as it was originally packaged at the factory.

When setting up the unit

The picture and sound of a nearby TV, VCR, or radio may be distorted during playback. In this case, position the unit away from the TV, VCR, or radio, or turn off the unit after removing the disc.

To keep the surface clean

Do not use volatile liquids, such as insecticide spray, near the unit. Do not leave rubber or plastic products in contact with the unit for a long period of time. They will leave marks on the surface.

Cleaning the unit

To clean the cabinet

Use a soft, dry cloth. If the surfaces are extremely dirty, use a soft cloth lightly moistened with a mild detergent solution. Do not use strong solvents such as alcohol, benzene, or thinner, as these might damage the surface of the unit.

To obtain a clear picture

The DVD+VCR is a high-tech, precision device. If the optical pick-up lens and disc drive parts are dirty or worn, the picture quality will be poor. Regular inspection and maintenance are recommended after every 1,000 hours of use. (This depends on the operating environment.) For details, please contact your nearest dealer.

Notes on Discs

Handling discs

Do not touch the playback side of the disc. Hold the disc by the edges so that fingerprints will not get on the surface. Do not stick paper or tape on the disc.

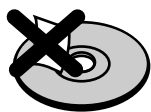
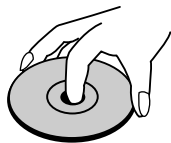

Storing discs

After playing, store the disc in its case. Do not expose the disc to direct sunlight or sources of heat, or leave it in a parked car exposed to direct sunlight, as there may be a considerable temperature increase inside the car.

Cleaning discs

Fingerprints and dust on the disc can cause poor picture quality and sound distortion. Before playing, clean the disc with a clean cloth. Wipe the disc from the center outward.

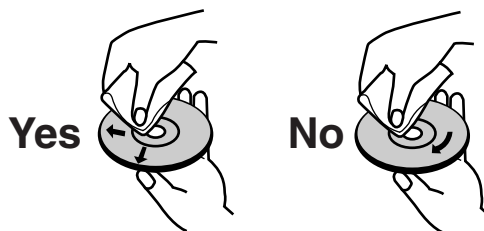

Do not use strong solvents such as alcohol, benzene, thinner, commercially available cleaners, or anti-static spray intended for older vinyl records.



About Symbols

About the symbol display

“” may appear on the TV screen during operation. This icon means the function explained in this owner's manual is not available on that specific DVD video disc.

About the disc symbols for instructions

A section whose title has one of the following symbols are applicable only to those discs represented by the symbol.

-  DVD
-  Audio CDs.
-  MP3 Discs.

Front Panel

POWER

Switches the DVD+VCR ON and OFF.

EJECT

Ejects the tape in the VCR deck.

LINE2 (VIDEO IN/AUDIO IN (Left/Right))

Connect the audio/video output of an external source (Audio system, TV/ Monitor, Another VCR).

VOLUME

Adjusts volume of speakers.

Disc Tray (DVD deck)

Insert a disc here.

PAUSE/STEP (II/II▶)

Pause playback or recording temporarily/press repeatedly for frame-by-frame playback.

TUNING (▲/▼)

Scans an available channel in the area.

STOP (■)

Stops playback.

COPY/MEMORY

Press to copy a DVD in the DVD deck to a VCR tape in the VCR deck.

Memorizes currently tuned Radio frequency (station).

PLAY (▶)

To play back a recorded tape.

REC/ITR (●)

To record normally or to activate Instant Timer Recording.

Cassette Compartment (VCR deck)

Insert a video cassette here.

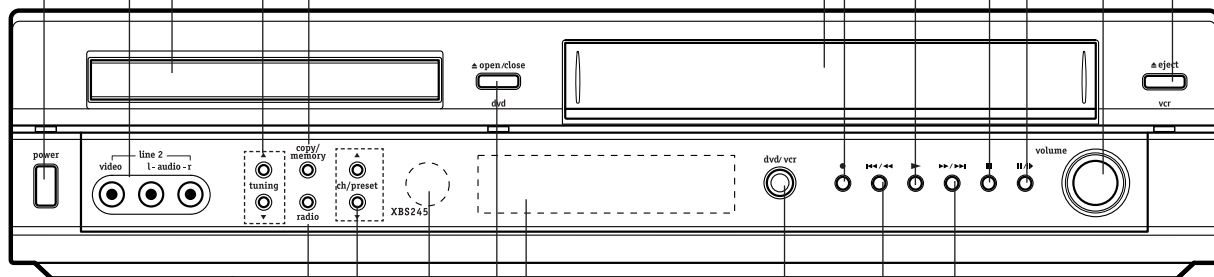

RADIO (AM/FM)

Selects Radio operation mode.

Display window

Shows the current status of the DVD+VCR.

CH/PRESET (▲/▼)

Scans up or down through memorized channels or radio frequencies (stations).

OPEN/CLOSE

Opens or closes the disc tray.

Remote Sensor

Point the DVD+VCR remote control here.

DVD/VCR

Toggles control between the DVD deck and the VCR deck.

FORWARD (▶▶/▶▶▶)

DVD: Go to NEXT chapter/track. Press and hold for two seconds for a fast forward search.

VCR: Advances the tape during the STOP mode or for fast forward picture search.

BACKWARD (◀◀/◀◀◀)

DVD: Go to beginning of current chapter/track or to previous chapter/track.

Press and hold for a fast reverse search.

VCR: Rewinds the tape during the STOP mode or for fast reverse picture search.

Display Window

RAND RANDOM playback active

SP LP EP Displays the recording and playback speed.

Indicates repeat mode

A cassette is in the VCR deck.

 **ANGLE** active

PROG. Programmed playback active.

Indicates encoding format of the current disc.

HI-FI Indicates the unit is playing back a tape recorded in Hi-Fi.

COPY DVD to VCR copy is in progress.

OPT Indicates source of DVD+VCR is DIGITAL AUDIO IN.

Indicates sound mode is PROLOGIC II.

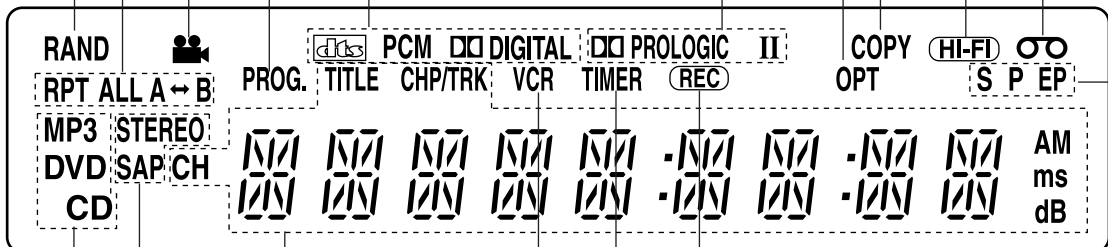

REC DVD+VCR is Recording.

TIMER DVD+VCR is in timer recording or a timer recording is programmed.

VCR DVD+VCR functions are available and channels are selected at DVD+VCR.

Indicates clock, total playing time, elapsed time, remaining time, title number, chapter/track number, channel, radio frequency, level, volume, channel or current deck status (Playback, Pause, etc).

STEREO Indicates a stereo broadcast is being received.

SAP Indicates when a SAP BILINGUAL broadcast is being received.

DVD DVD inserted.

CD Audio CD inserted.

MP3 MP3 disc inserted

Remote Control

OPEN/CLOSE, EJECT (▲)

- Opens and closes the disc tray.
- Ejects the tape in the VCR deck.

AUX/DVD/VCR/RADIO select buttons

Select the output source (DVD, VCR, AUX or RADIO) to view on the TV screen.

LEVEL

Sets the sound level of each speaker.

DELAY

Sets the delay time of each speaker.

TEST TONE

A hiss noise comes out for 2 seconds from each speakers.

MUTE

Turn off speaker's sound.

0-9 numerical buttons

Selects numbered options in a menu.

PROGRAM

Accesses or removes Program menu.

MARKER

Marks any point during playback.

SEARCH

Displays MARKER SEARCH menu.

INPUT

To select the VCR deck's source (Tuner, LINE 1, or LINE 2).

OUTPUT SELECT

Cycles through the 3 main output views: DVD, Tuner and VCR.

VOLUME (+/-)

Adjusts volume of speaker.

RETURN

Removes the setup menu.

STOP (■)

Stops playback.

PAUSE/STEP (II)

Pause playback or recording temporarily/press repeatedly for frame-by-frame playback.

PLAY (▶)

Starts playback.

REC/TR (●)

Records normally or activates Instant Timer Recording.

A-B, SPEED

- Repeats sequence.
- Selects recording speed

REPEAT

Repeat chapter, track, title, all.

RANDOM, CM SKIP

- Plays tracks in random order.
- Fast forwards picture search through 30 seconds of recording.

POWER

Switches DVD+VCR ON and OFF.

SOUND EFFECT

Selects sound mode.

PROLOGIC II

Selects sound mode of PROLOGIC II.

BY PASS

Sets PRO LOGIC II mode to Off

CLEAR

Removes a track number on the program menu or a mark on the MARKER SEARCH menu.

AUDIO

Selects an audio language (DVD) or an audio channel (CD).

ZOOM

Enlarges DVD video image.

ANGLE

Selects a DVD camera angle if available.

SUBTITLE

Selects a subtitle language.

TITLE

Displays the disc's Title menu, if available.

DISPLAY, CLK/CNT

Accesses On-Screen display.

Switches among the clock, tape counter and tape remaining modes on the display.

SETUP, MENU

Accesses or removes DVD setup menu and VCR menu.

◀/▶/▲/▼ (left/right/up/down)

- Selects an option in the menu

- **CH/TRK (▲/▼)**: Selects channel of VCR.

Adjusts manually the tape's picture onscreen.

DISC MENU

Accesses menu on a DVD disc.

TV/VCR

To view channels selected by the VCR tuner or by the TV tuner.

SELECT/ENTER

- Acknowledges menu selection.

- Displays functions on the TV screen.

FORWARD (▶▶▶)

Search forward*/go to next chapter or track (DVD). Advances the tape during the STOP mode or for fast forward picture search. (VCR)

BACKWARD (◀◀◀)

Search backward*/go to beginning of current chapter or track or go to previous chapter or track (DVD). Rewinds the tape during the STOP mode or for fast reverse picture search. (VCR)

* Press and hold button for about two seconds.

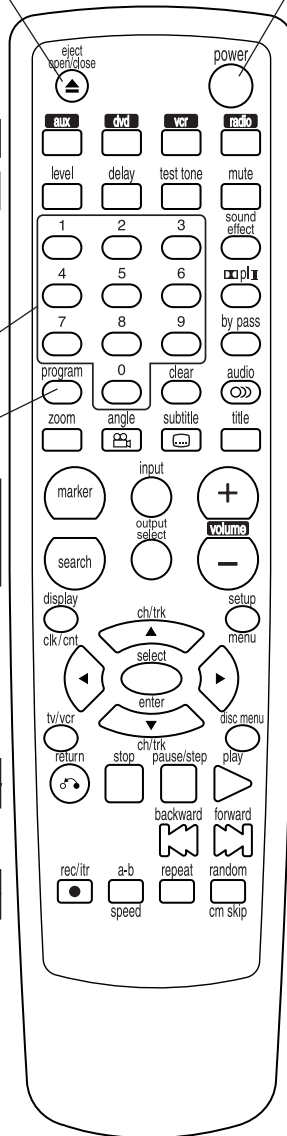

Note

This remote control uses the same buttons for VCR or DVD functions (ex. PLAY). When using the VCR, first press the VCR button. When using the DVD, first press the DVD button.

Rear Panel

VCR IN LINE 1 (VIDEO IN/AUDIO IN (Left/Right))
Connect the audio/video output of an external source (Audio system, TV/Monitor, Another VCR).

DVD/VCR OUT (VIDEO/AUDIO (Left/Right))
Connect to a TV with video and audio inputs.

RF OUT (DVD/VCR OUT)
Connect to a TV with RF coaxial inputs.

COMPONENT VIDEO OUT/PROGRESSIVE SCAN (Y Pb Pr) (DVD OUT)
Connect to a TV with Y Pb Pr inputs. **FOR DVD VIEWING ONLY.**

ANT.IN
Connect the VHF/UHF/CATV antenna to this terminal.

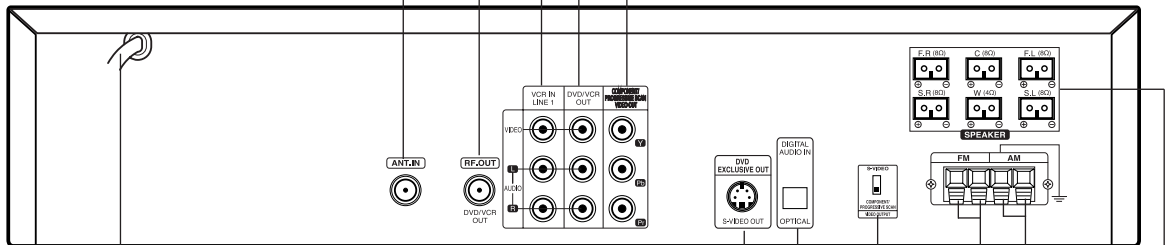

AC Power Cord
Plug into the power source.

S-VIDEO OUT (DVD OUT)
Connect to a S-Video Input on TV. **FOR DVD VIEWING ONLY.**

DIGITAL AUDIO IN (OPTICAL)
Connect to a digital audio output on a digital device.

VIDEO OUTPUT Switch
Select either S-VIDEO OUT or COMPONENT VIDEO OUT/PROGRESSIVE SCAN, depending on how you connected the DVD+VCR to the TV.

FM Antenna Connectors
Connect the FM antenna to this terminal.

AM Antenna Connectors
Connect the AM antenna to this terminal.

Dust Protection Cap

Remove the dust protection cap from the OPTICAL DIGITAL IN jack and connect the optical digital cable (not supplied) securely so that the configurations of both the cable and the connector match. Keep the dust protection cap and always reattach the cap when not using the connector to protect against dust intrusion.

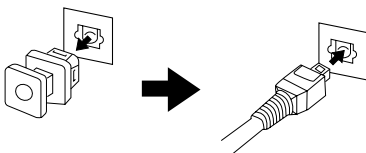

Do not touch the inner pins of the jacks on the rear panel. Electrostatic discharge may cause permanent damage to the unit.

SPEAKER Connectors
Connect the six supplied speakers to these terminals.

Connections

Tips

- Depending on your TV and other equipment you wish to connect, there are various ways you could connect the DVD+VCR. Use connections described on pages 11-14.
- Please refer to the manuals of your TV, VCR, Stereo System or other devices as necessary to make the best connections.

Caution

- Make sure the DVD+VCR is connected directly to the TV. Tune the TV to the correct video input channel.
- Do not connect the DVD+VCR's DVD/VCR AUDIO OUT jack to the phono in jack (record deck) of your audio system.
- Do not connect your DVD+VCR via your VCR. The DVD image could be distorted by the copy protection system.

Connecting Antenna/Cable TV to DVD+VCR

- 1 Disconnect the antenna leads from the rear of the TV.
- 2 Identify the type of cable from your antenna. If it is a round cable as illustrated, it is a 75 ohm coaxial antenna cable. This cable will connect directly to the jack marked ANT.IN on your DVD+VCR.

Tip

If your antenna lead wire is a flat type antenna cable, connect it to an Antenna Adaptor (300-ohm to 75-ohm) (not supplied) and slip the Adaptor onto the ANT.IN jack. The Adaptor does not screw on to the DVD+VCR, it just slips over the jack.

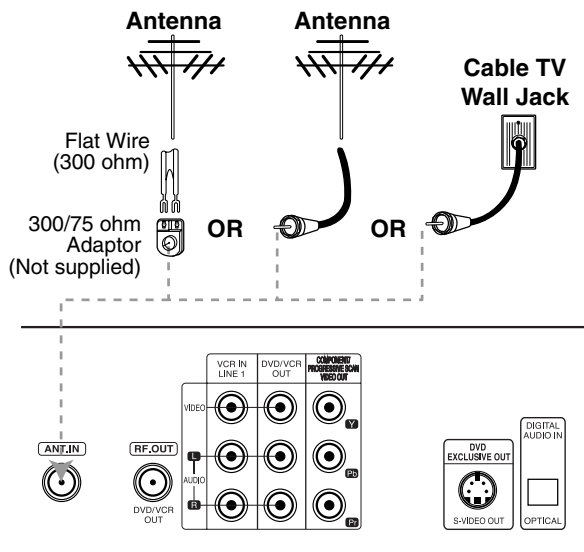

Rear of DVD+VCR

Without Cable Box

If your cable wire is connected to your TV without a converter or descrambler box, unscrew the wire from your TV and attach it to the ANT.IN jack on the DVD+VCR. Use the supplied round coaxial cable to connect between the DVD+VCR's RF.OUT jack and the 75 ohm antenna input jack on the TV. With this connection, you can receive all midband, super band, and hyperband channels.

With Cable Box

If a converter is required in your cable system, follow the instruction below:

The cable hookup permits both TV and DVD+VCR operation.

To view or record a CATV channel

- 1 Tune the TV to the DVD+VCR output channel (CH 3 or 4).
- 2 Set the DVD+VCR channel selector to the output channel of the Cable Converter box using CH/TRK (▲/▼) or number (0-9) of your DVD+VCR. (Example: CH3)
- 3 Select the channel to view at the Cable Converter Box.

Notes

- With this connection, you CANNOT record one program while viewing another.
- If you are using a cable box to tune channels, it is not necessary to do Auto Channel Programming, (Auto Channel Search) as indicated on page 20.

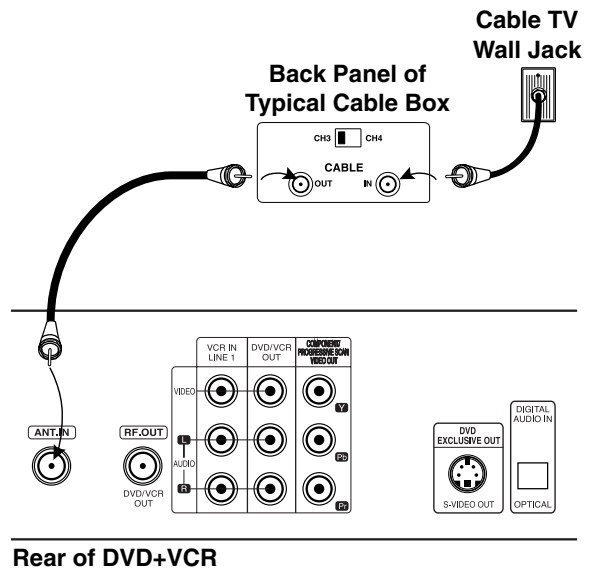

Rear of DVD+VCR

Connections (Continued)

Basic TV Connections

- Make one of the following connections, depending on the capabilities of your TV.

RF coaxial connection

Connect the RF.OUT jack on the DVD+VCR to the antenna in jack on the TV using the 75-ohm Coaxial Cable supplied (**R**).

Note

If you use this connection, tune the TV to the DVD+VCR's RF output channel (CH 3 or 4).

How to set the DVD+VCR's RF output channel

When the DVD+VCR is turned off, press and hold CH/PRESET (▲/▼) on the front panel for about five seconds to change the RF output channel (CH 03 or CH 04). "RF 03" or "RF 04" appears in the display window.

Audio/Video connection

- 1 Connect the DVD/VCR VIDEO OUT jack on the DVD+VCR to the video in jack on the TV using the supplied video cable (**V**).
- 2 Connect the Left and Right DVD/VCR AUDIO OUT jacks on the DVD+VCR to the audio left/right in jacks on the TV (**A**) using the supplied audio cables.

Note

If you use this connection, set the TV's source selector to VIDEO.

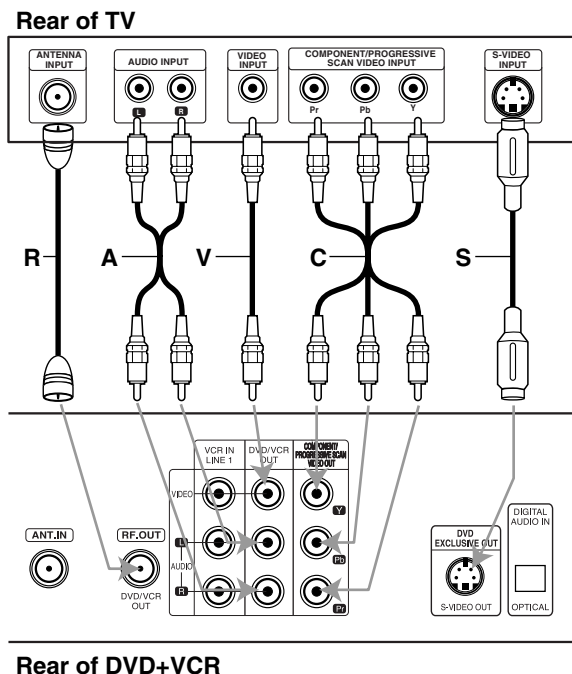

Optional TV Connections

Notes

- DVD playback can ONLY be done using the S-VIDEO OUT and COMPONENT VIDEO OUT/PROGRESSIVE SCAN connection options below. The tuner and VCR will still output through the RF.OUT (**R**) or DVD/VCR OUT (**A, V**) jack. (See left)
- When using the COMPONENT VIDEO OUT/PROGRESSIVE SCAN jacks, set the VIDEO OUTPUT switch to COMPONENT/PROGRESSIVE SCAN. When using the S-VIDEO OUT jack, set the VIDEO OUTPUT switch to S-VIDEO.

S-Video Connection

- 1 Connect the S-VIDEO OUT jack on the DVD+VCR to the S-Video in jack on the TV using the supplied S-Video cable (**S**).
- 2 Connect the Left and Right AUDIO OUT jacks on the DVD+VCR to the audio left/right in jacks on the TV using the supplied audio cables (**A**).

Component Video (Color Stream®) connection

- 1 Connect the COMPONENT VIDEO OUT/PROGRESSIVE SCAN jacks on the DVD+VCR to the corresponding in jacks on the TV using user-supplied Y Pb Pr cables (**C**).
- 2 Connect the Left and Right AUDIO OUT jacks of the DVD+VCR to the audio left/right in jacks on the TV (**A**) using the supplied audio cables.

Progressive Scan (ColorStream® pro) connection

- If your television is a high-definition or "digital ready" television, you may take advantage of the DVD+VCR's progressive scan output for the highest video resolution possible.
- If your TV does not accept the Progressive Scan format, the picture will appear scrambled if you try Progressive Scan on the DVD+VCR.

- 1 Connect the COMPONENT VIDEO OUT/PROGRESSIVE SCAN jacks on the DVD+VCR to the corresponding in jacks on the TV using an optional Y Pb Pr cable (**C**).
- 2 Connect the Left and Right AUDIO OUT jacks of the DVD+VCR to the audio left/right in jacks on the TV (**A**) using the supplied audio cables.

Notes

- Set the Progressive Scan to "On" on the DVD setup menu for progressive signal, see page 23.
- Progressive scan does not work with the analog video connections (yellow VIDEO OUT jack).

Connections (Continued)

Speaker System Connections

Connect the speakers using the supplied speaker cords by matching the colors of the terminals and those of the cords. To obtain the best possible surround sound, adjust the speaker parameters (distance, level, etc.).

Notes

- Be sure to match the speaker cord to the appropriate terminal on the components: ⊕ to ⊕ and ⊖ to ⊖. If the cords are reversed, the sound will be distorted and lack bass.
- If you use front speakers with low maximum input rating, adjust the volume carefully to avoid excessive volume output to the speakers.
- Do not disassemble the front covers of supplied speakers.

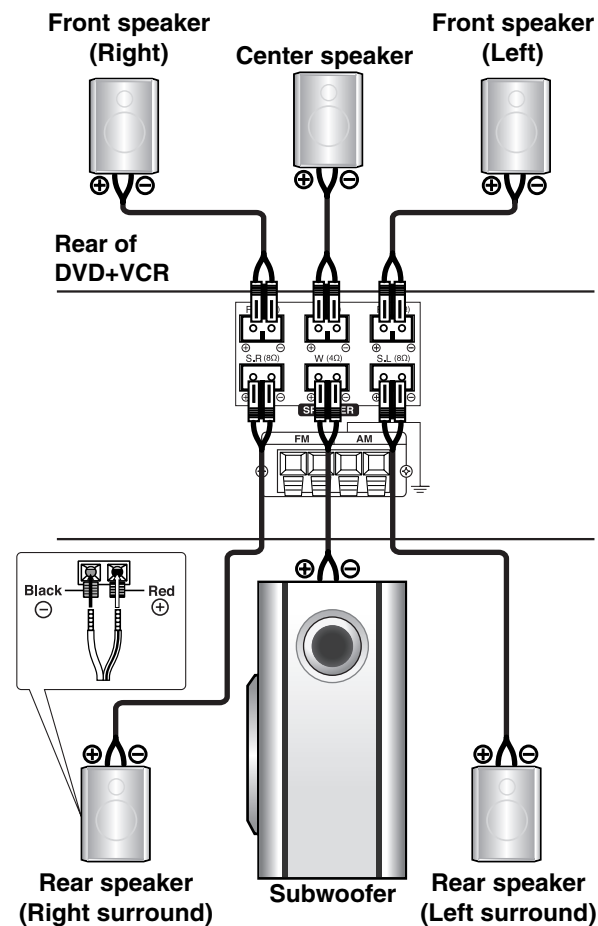

Speaker Positioning

For a normal setup use 6 speakers (2 front speakers, center speaker, 2 rear speakers and subwoofer).

- **Front Speakers**
Based on your listening position, set up the speakers at equal distance. And by hearing position, set up an interval between speakers of 45 degree.
- **Center Speaker**
It is ideal that the center speakers and front speakers are same height. But normally place it above or below the television as shown below.
- **Rear Speakers**
Place left and right behind the listening area. These speakers recreate sound motion and atmosphere required for surround playback. For best results, do not install the rear speakers too far behind the listening position, install them at or above the level of the listener's ears. It is also effective to direct the rear speakers towards a wall or ceiling to further disperse the sound.
In the case of a smaller room size, if the audience is near to the rear wall set the rear speakers opposite each other, and set the rear speakers 60 - 90 cm above the listener's ears.
- **Subwoofer**
This can be placed in any front position.

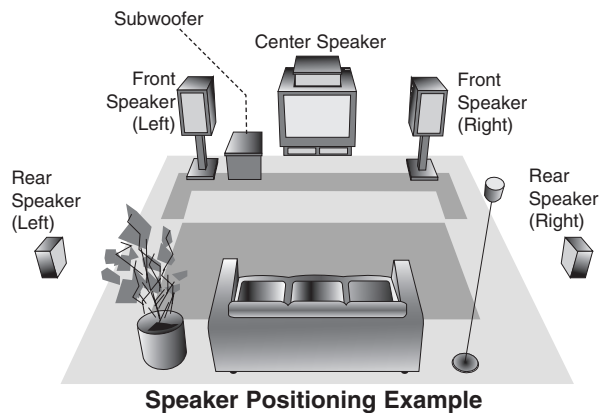

IMPORTANT NOTE

After connecting the speakers and DVD+VCR, bind the speaker cables with the provided Ferrite Core as right.

The Ferrite Core has the function which reduces the electromagnetic effect which this DVD+VCR gives to the other products

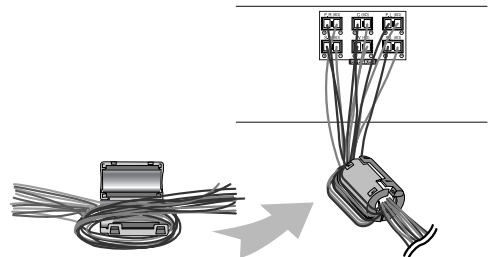

Connections (Continued)

Radio Antenna Connections

Connect the supplied FM/AM antennas for radio listening.

- 1 Connect the AM loop antenna to the AM antenna connectors.
- 2 Connect the FM wire antenna to the FM antenna connectors.

Notes

- To prevent noise pickup, keep the AM loop antenna away from the DVD+VCR and other components.
- Be sure to fully extend the FM wire antenna.
- After connecting the FM wire antenna, keep it as horizontal as possible.

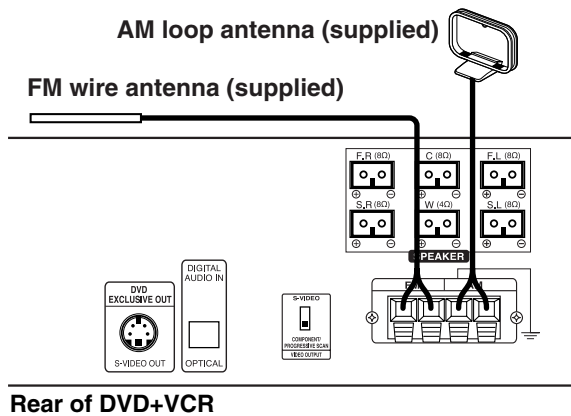

Accessory Audio/Video (A/V) Connections to DVD+VCR

Connect the VCR IN LINE1 or LINE2 jacks on the DVD+VCR to the audio/video out jacks on your accessory component, using optional audio/video cables.

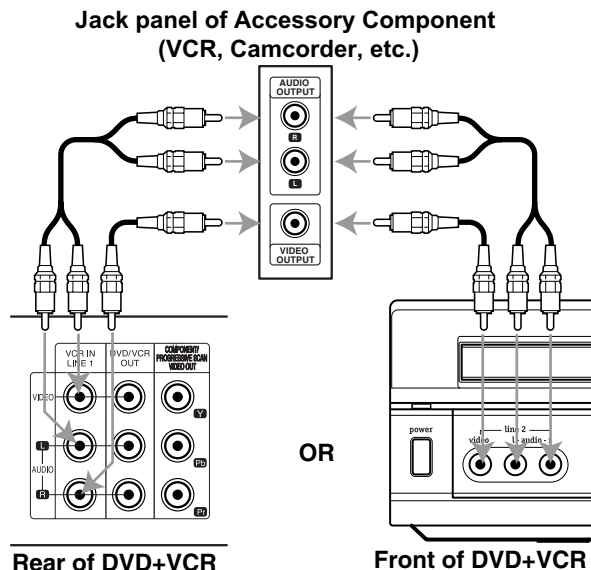

Digital Device Connections

Connect the DIGITAL AUDIO IN (OPTICAL) jacks on the DVD+VCR to the digital audio out (optical) jacks on your digital device (DVD Player, Game device, etc.), using optional optical audio cable.

To select source of DVD+VCR to OPTICAL IN, press AUX on the remote control.

Notes

- If the audio format of the digital output does not match the capabilities of your DVD+VCR, the DVD+VCR will produce a strong, distorted sound or no sound at all.
- The Optical input function is available only when the other unit's Sampling Frequency is 32 - 48kHz.

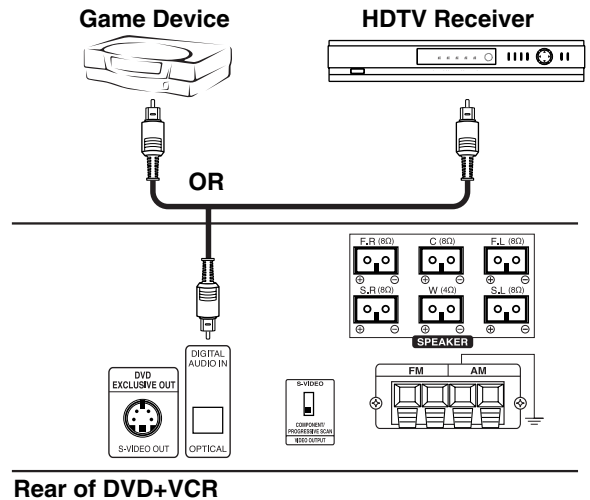

Selecting the Input/Output Source

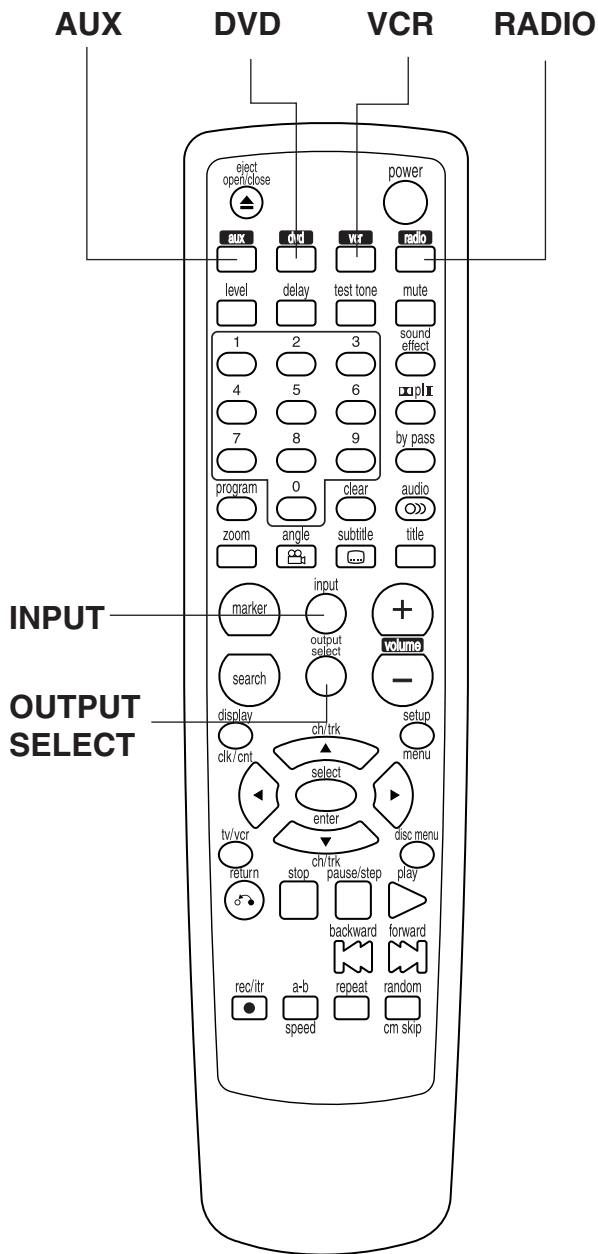

Follow these guidelines to select and switch among the various DVD+VCR input and output sources:

- **DVD**

- To view output from the DVD deck:**

- Press DVD on the remote or DVD/VCR on the front panel until the DVD indicator on the front panel lights and output from the DVD deck is viewed on the TV screen.

- **VCR**

- To view output from the VCR deck:**

- Press VCR on the remote or DVD/VCR on the front panel until the VCR indicator on the front panel lights and output from the VCR deck is viewed on the TV screen.

- **RADIO**

- To listen to AM/FM radio broadcasts:**

- Press RADIO on the remote to toggle between AM and FM radio. The selected frequency appears on the front panel display.

- **AUX**

- To listen to an audio source connected to the DIGITAL AUDIO IN (OPTICAL) jack:**

- Press AUX on the remote control. OPTICAL IN appears on the front panel and on-screen display. Audio will come from an external source connected to the DIGITAL AUDIO IN (OPTICAL) jack.

- To view video from Line 1 along with audio from the DIGITAL AUDIO IN (OPTICAL) jack:**

- Press VCR to select the VCR deck, and then press INPUT to select LINE1 to view the video source connected to the rear panel. Finally, press AUX to listen to the audio from the DIGITAL AUDIO IN (OPTICAL) jack with LINE1 video.

- **INPUT**

- To view a source connected to the front or rear LINE inputs:**

- First, press VCR to select the VCR deck, and then press INPUT to select LINE1 (for rear panel) or LINE2 (for front panel).

- **OUTPUT SELECT**

- To quickly select DVD, VCR or Tuner:**

- Cycles through the 3 main output views: DVD, Tuner and VCR.

- DVD: To view the current DVD deck status (disc playback, DVD menu, setup menu, etc.).

- Tuner: To view TV programs through the TV tuner.

- VCR: To view the current VCR deck status (tape playback, VCR programming, viewing TV programs through the VCR tuner, etc.).

Before Operation - Sound Mode Descriptions

Mini Glossary for Sound Mode

dtS

Allows you to enjoy 5.1(or 6) discrete channels of high quality digital audio from DTS program sources bearing the trademark such as discs, DVD and compact discs, etc. DTS Digital Surround delivers up to 6 channels of transparent audio (which means identical to the original masters) and results in exceptional clarity throughout a true 360 degree sound field. The term DTS is a trademark of DTS Technology, LLC. Manufactured under license from DTS Technology, LLC.

DIGITAL

The Dolby Digital surround format lets you enjoy up to 5.1 channels of digital surround sound from a Dolby Digital program source. If you play DVDs with “” mark, you can enjoy even better sound quality, greater spatial accuracy, and improved dynamic range.

HALL 1

When playing recordings of live music and classic, this mode provides a feeling similar to actually being in a small concert hall.

HALL 2

When playing recordings of live music and classic, this mode provides a feeling similar to actually being in a large concert hall.

THEATER

This mode provides a three dimensional effect similar to that of movie theater.

PRO LOGIC II

Dolby Pro Logic II creates five full-bandwidth output channels from two-channel sources. This is done using an advanced, high-purity matrix surround decoder that extracts the spatial properties of the original recording without adding any new sounds or tonal colorations. Pro Logic II offers the following five modes:

PROLOGIC Emulation mode:

The Pro Logic Emulation mode offers users the same robust surround processing as original Pro Logic, in case the source content is not of optimum quality, or if there is a desire to hear the program more “as it used to be.” When this mode is used, it is called Pro Logic, as before. There is no “Pro Logic I” mode. The Pro Logic emulation mode is optional.

MOVIE mode:

Movie mode is for use with stereo television shows and all programs encoded in Dolby Surround. The result is enhanced sound field directionality that approaches the quality of discrete 5.1-channel sound.

MUSIC mode:

Music mode is for use with any stereo music recordings, and provides a wide and deep sound space. The Music mode includes controls that allow the sound to be tailored to individual listening tastes.

VIRTUAL mode:

Virtual mode is usually used when Pro Logic II is connected to a virtual process for speaker use. However, there might be some virtualizers for which this mode does not produce the intended result. For those virtualizers, Movie mode may give the best surround effect. Virtual mode is designed to be used with the virtual process developed by Dolby Laboratories. The Pro Logic II mode should be called only “Pro Logic II” so the Virtual name can be reserved to describe the speaker virtualization process itself.

MATRIX mode:

The Matrix mode is the same as the Music mode except that the directional enhancement logic is turned off. It may be used to enhance mono signals by making them seem “larger.” The Matrix mode may also find use in auto systems, where the fluctuations from poor FM stereo reception can otherwise cause disturbing surround signals from a logic decoder. The ultimate “cure” for poor FM stereo reception may be simply to force the audio to mono.

SURROUND OFF (2CH STEREO)

Outputs the sound from the front left and right speakers and subwoofer. Standard two channel (stereo) sources completely bypass the sound field processing. This allows you to play any source using only the front left and right speakers and subwoofer. **You can select SURROUND OFF by pressing BY PASS on the remote control.**

Before Operation - Sound Mode Descriptions (Continued)

Sound Mode

You can enjoy surround sound simply by selecting one of the pre-programmed sound fields according to the program you want to listen to.

Each time you press SOUND EFFECT button, the sound mode is changed in the following order;

PROLOGIC → HALL 1 → HALL 2 → THEATER



Note

For the DVD, you can select only when **PCM** indicator is shown in the display window.

Each time you press  button, the sound mode of Pro Logic II is changed in the following order;

PROLOGIC → MOVIE → MUSIC → VIRTUAL → MATRIX



Tip

You can select SURROUND OFF (2CH STEREO) mode by pressing BY PASS button.

When DVD is inserted.

You can change the sound mode of DVD (Dolby Digital, DTS, PRO LOGIC, etc) by pressing the **AUDIO** button on the remote during playback.

Although the DVD contents differ from disc to disc, the following explains the basic operation when this feature is used.

Each time you press AUDIO button, the sound mode of DVD is changed in the following order;

 → DIGITAL → DIGITAL and PRO LOGIC



When DVD is inserted and PROLOGIC II indicator lights.

Each time you press  button, the sound mode of Pro Logic II is changed in the following order;



PROLOGIC → MOVIE → MUSIC → VIRTUAL → MATRIX



Tip

You can set PRO LOGIC II mode to Off (2CH STEREO) by pressing BY PASS button and the PROLOGIC II indicator disappears.

For your reference

- The DVD+VCR memorizes the last mode settings for each source individually.
- You can identify the encoding format of program software by looking at its packaging.
 - Dolby Digital discs are labeled with the  logo.
 - Dolby Surround encoded programs are labeled with the  logo.
 - DTS Digital Surround discs are marked with DTS.

Note

When you play sound tracks with 96kHz sampling frequency, the output signals will be converted to 48kHz (sampling frequency).

Sound Level

You can set the sound level of the desired channel.

1 Press LEVEL.

The level indicator will appear in the display window.

2 Use to select a desired speaker to set.

Each time you press the  button, it is changed as the following order;

FL (Front Left) ↔ C (Center) ↔ FR (Front Right) ↔

SR (Surround Right) ↔ SL (Surround Left) ↔

SW (Subwoofer) ↔ FL (Front Left)

- On the 2 channel stereo mode, you can only select the SW (Subwoofer).

3 Use to adjust the sound level of the selected channel. (-6dB - +6dB)

4 Repeat step 2-3 and adjust the sound level of the other channels.

5 If setting is complete, press LEVEL.

Test Tone

This function allows you can easily adjust the sound balance of the speakers from the listener's position.

1 Select the test tone mode by pressing TEST TONE.

- A hiss noise comes out for 2 seconds from each speakers in the following order;
FL (Front Left) → C (Center) → FR (Front Right) →
SR (Surround Right) → SL (Surround Left) →
SW (Subwoofer) → FL (Front Left)

2 You can adjust the sound level during operating the test tone, first press LEVEL then press buttons, so that all speaker's sound level is same from the listener's position.

- During operating the test tone, if you adjust the sound level, it will be paused in the current speaker channel.

3 If setting is complete, press TEST TONE.

Before Operation (Continued)

Delay Time Setting

In Dolby Digital or Dolby Pro Logic II mode, it is assumed that the distance from the listener to each of the speakers is equal. If not, then setting the delay times of the center or rear speakers so that the sound will be heard simultaneously by the listener.

The interval from the speakers to the listener. If the distance from the listener to each speaker is same, in the Dolby Digital and Dolby Pro Logic II mode, the delay time of each speakers is as follows.

In Dolby Digital mode

Center delay time : 0 ms (0-5 ms)

Surround delay time: 5 ms (0-15 ms)

In Dolby Pro Logic II mode

Center delay time : cannot set

Surround delay time:

- PROLOGIC: 10 - 25 msec
- MOVIE: 10 - 25 msec
- MUSIC: 0 - 15 msec
- VIRTUAL: cannot set
- MATRIX: 0 - 15 msec

If the surround delay time is set in Dolby Digital mode, in the Dolby Pro Logic II mode, the delay time will be automatically set.

The delay time is 1 msec per 30 cm.

If the center and rear speakers are further than the front speakers from the listener, the delay time will be at minimum.

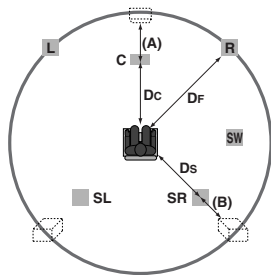

Surround delay time setting

If the distance of Ds is equal to or longer than the Df in the above figure, set the Surround Delay Time as 0ms. Otherwise, change the setting according to the below.

Ex) If the distance from front speakers to the listener is 3 m and from rear speakers from the listener is 1.5 m, in the Dolby Digital mode the surround delay time is 5 msec.

$3\text{m (Df)} - 1.5\text{m (Ds)} = 1.5\text{ m (B)}$

$1.5\text{m (B)} = 150\text{cm} / 30\text{ cm} = 5\text{ msec}$

Center delay time setting (Dolby Digital mode only)

If the distance of Df is equal to the distance of Dc in the left figure, set the Center Delay Time as 0ms.

Otherwise, change the setting according to the table below.

Ex) If the distance from the front speakers to the listener is 3 m and from the center speaker to the listener is 2.4 m, the center delay time is 2 msec.

$3\text{m (Df)} - 2.4\text{m (Dc)} = 60\text{cm (A)}$

$60\text{cm (A)} / 30\text{cm} = 2\text{msec}$

Setting the delay time in the Dolby Digital and Dolby Pro Logic II mode

1 Press DELAY.

The current surround delay time appears in the display window.

You can select center delay time by pressing ◀▶ in the Dolby Digital mode only.

2 Use ▲▼ to change the delay time.

3 If setting is complete, press DELAY.

Notes

You can adjust the center delay time only in the Dolby Digital mode and its delay time appears.

Center Width (MUSIC mode of Dolby Pro Logic II only)

This control allows center-channel sounds to be positioned between the center speaker and the left/right speakers over a range of eight steps. Step "3" uses a combination of all three front speakers to give the best vocal imaging and most seamless soundstage presentation, and is recommended for most recordings. Step "0" places all center sound in the center speaker. Step "7" places all center sound equally in the left/right speakers, just as in conventional stereo.

DIMENSE (MUSIC mode of Dolby Pro Logic II only)

This control allows the user to gradually adjust the sound field either towards the front or the rear. This can be useful to help achieve the desired balance from all the speakers with certain recordings that may contain either too much or too little spatial effect. Step "0" is the recommended setting, which has no effect on the sound. Steps 1, 2, and 3 gradually move the sound forward, and steps -1, -2, and -3 move the sound towards the surrounds.

PANORAMA (MUSIC mode of Dolby Pro Logic II only)

This control extends the front stereo image to include the surround speakers for an exciting "wraparound" effect with side-wall imaging. It is particularly effective for recordings which have strong left- or right-channel elements in the mix, as these are detected and accentuated by the Panorama process.

Before Operation - VCR Mode

On-Screen Display (OSD)

Some of these functions will be displayed every time the VCR is operated.

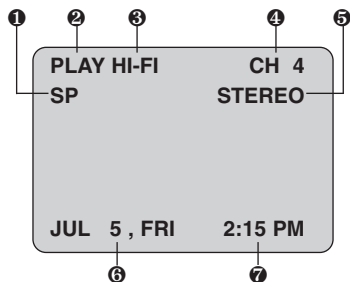

1 TAPE SPEED DISPLAY

Shows the current tape speed.

2 FUNCTION DISPLAY

Indicates the function in progress.

3 HI-FI DISPLAY

Indicates when this unit is playing back tape recorded with Hi-Fi.

4 CHANNEL DISPLAY

Indicates the selected channel (or LINE1, LINE2).

5 STEREO/SAP DISPLAY (MONO is not displayed)

Shows the type of audio signal received by the VCR tuner.

6 DATE DISPLAY

Shows the current date. (Month/Date/Day of the week format)

7 CLOCK/COUNT/REMAIN DISPLAY

Shows the current time, the tape counter and remaining time on the tape.

Each press of the **SELECT/ENTER** changes the TV screen in the following sequence.

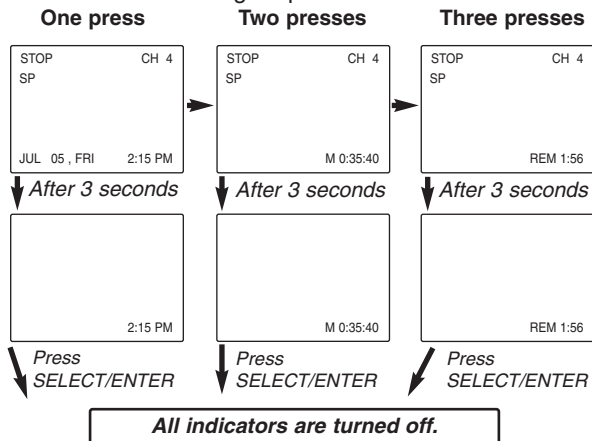

All indicators are turned off.

Notes

- The function displays can be seen displayed on the TV screen for 3 seconds.
- The clock (or tape counter, tape remaining) mode will continue until you press **SELECT/ENTER**.
- The tape counter and the remaining tape length indicator appear only when a cassette is inserted. Also, the remaining tape length indicator appears after any tape operation.

Setting the On-Screen Display

The SETUP, clock setting, and timer recordings are accessed conveniently with On-Screen Menu Displays that lead you through each step. The following pages describe the On-screen selections to be set.

Menu Selection

VCR functions are available using the remote control.

- Press **MENU** and the **MAIN** menu will appear.
- Select the desired menu with **▲/▼** button and then press **SELECT/ENTER**.

Note

Menus remain on-screen for 3 minutes.

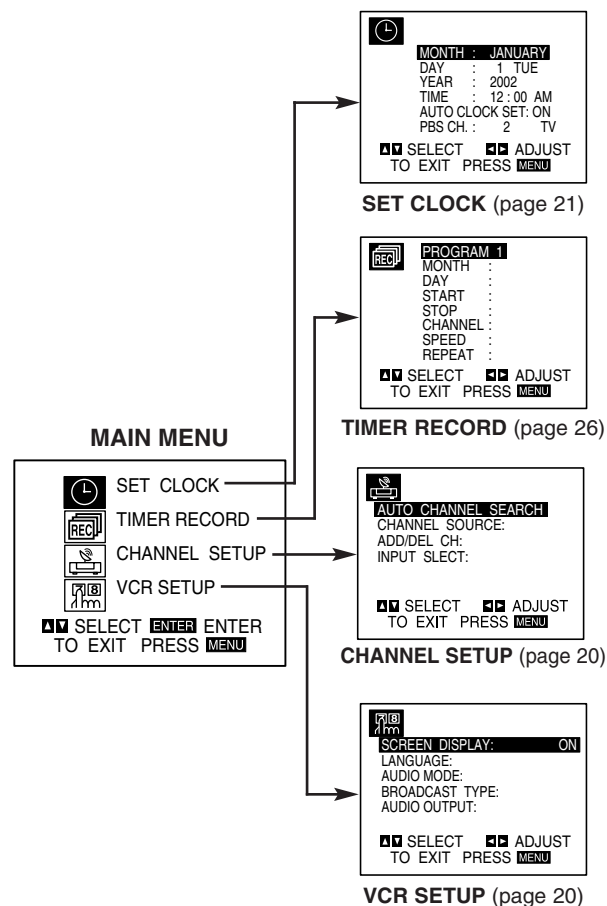

Before Operation - VCR Mode (Continued)

Using the VCR Setup Menu

- 1 Press **MENU** and the **MAIN** menu will appear.
- 2 Use **▲/▼** to select the **VCR SETUP** menu, then press **SELECT/ENTER**.
The **VCR SETUP** menu will appear.

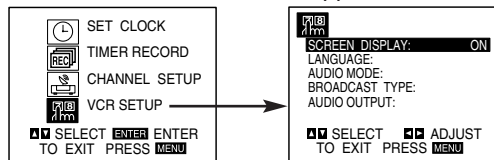

- 3 Use **▲/▼** to choose a desired option on the **VCR SETUP** menu. Then use **◀/▶** to choose a desired setting.

SCREEN DISPLAY

The on-screen display of this DVD+VCR can be turned on or off.

- **SCREEN DISPLAY** can be switched between **ON** and **OFF** by using **◀/▶**.

LANGUAGE

The on-screen programming of this DVD+VCR can be displayed in English, Spanish, or French.

- **LANGUAGE** can be switched among **ENGLISH**, **SPANISH** and **FRENCH** by using **◀/▶**.

AUDIO MODE

The DVD+VCR has two separate audio playback systems, the high-quality VHS Hi-Fi system and standard **NORMAL** mono system. The same audio is generally recorded on both systems. The VHS Hi-Fi system plays on separate (left and right) channels, and the **NORMAL** system plays monaural sound. The normal track is always played so the cassette can be played on a DVD+VCR that does not have VHS Hi-Fi.

- **AUDIO MODE** can be switched between **HI-FI** and **NORMAL** by using **◀/▶**.

BROADCAST TYPE (STEREO/SAP/MONO)

Multichannel Television Sound (MTS) carries stereo and/or Second Audio Program (SAP) bilingual signals. Set this display to the desired position when both MTS stereo and SAP signals are received. When only one of the MTS signal is received, the DVD+VCR automatically selects the corresponding receiving mode (Stereo or SAP) regardless of the selected position. For normal operation, the display should be in the **STEREO** position. The DVD+VCR will then record a **STEREO** program when available, and record a mono program if the program is **NOT IN STEREO**. For weak **STEREO** and/or **SAP** broadcasts, changing the display to mono may give clearer sound.

- **BROADCAST TYPE** can be switched among **STEREO**, **SAP**, and **MONO** by using **◀/▶**.

AUDIO OUTPUT (STEREO/LEFT/RIGHT)

Used during playback [when **AUDIO MODE** (**HI-FI**/**NORMAL**) is in **HI-FI** position] for selecting the audio output signals from the **AUDIO OUT** terminals (L ch and R ch), and **RF. OUT**.

This display setting should normally be left in the stereo position, so that when a stereo tape is played, the stereo sound will be heard through the left and right channels. If a mono tape is played and the audio output is set to stereo, the same mono sound will be heard from both left and right channels.

- **AUDIO OUTPUT** can be switched among **STEREO**, **LEFT**, and **RIGHT** by using **◀/▶**.

Channel Selection

This DVD+VCR is equipped with a frequency synthesized tuner capable of receiving up to 181 channels. These include VHF channels 2-13, UHF channels 14-69 and CATV channels 1-125.

Preparation:

- Connect the DVD+VCR to the desired type of antenna or cable TV system, as shown in Connecting Antenna/Cable TV to DVD+VCR on page 11.

AUTO CHANNEL PROGRAMMING

- 1 Press **MENU** and the **MAIN** menu will appear.
- 2 Use **▲/▼** to select the **CHANNEL SETUP** menu, then press **SELECT/ENTER**.
The **CHANNEL SETUP** menu will appear.

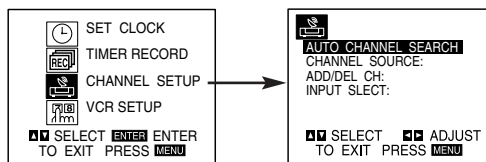

- 3 Use **▼** to choose the **INPUT SELECT** option, then use **◀/▶** to select **TUNER**.
Press **◀/▶** repeatedly to switch among **TUNER**, **LINE1** and **LINE2**.
- 4 Use **▲/▼** to choose the **AUTO CHANNEL SEARCH** option, then use **◀/▶** to find channels.
The tuner will automatically cycle through all available channels in the area and place them in the tuner's memory.
- 5 After the **AUTO CHANNEL SEARCH PROCEEDING** is complete, make sure the **CHANNEL SOURCE** is set appropriately (**TV** or **CATV**) by pressing **▲/▼** and choosing the correct **CHANNEL SOURCE** (**TV** or **CATV**) by using **◀/▶** using the **CHANNEL SETUP** menu.
Remember, **TV** is for the air antenna reception, **CATV** is for cable or wireless cable connection.
- 6 Press **MENU** to return to the **TV** screen.
- 7 Use **CH/TRK (▲/▼)** or **CH/PRESET (▲/▼)** on the front panel to cycle the DVD+VCR through the channels in memory.

TO ADD OR ERASE CHANNELS FROM MEMORY

This feature allows you to add or erase channels from memory manually.

- 1 Press **▼** to choose the **ADD/DEL CH** option on the **CHANNEL SETUP** menu. Use **◀/▶** to select a channel to add or erase.
- 2 Press **SELECT/ENTER** to add or erase the channel. Repeat steps 1 and 2 to add or erase channels.
- 3 Press **MENU** to return to the **TV** screen.

Before Operation - VCR Mode (Continued)

Setting the Clock

The DVD+VCR gives you two ways to set the time and date: the Auto Clock Feature or manually. The Auto Clock Feature enables the DVD+VCR to set up the clock when the DVD+VCR is turned off.

Things to know before starting

- The clock uses the 12-hour system. (Be sure to set AM and PM correctly.)
- The initial Clock Setting is **JANUARY 1, 2002, 12:00 AM**.

Auto Clock Set

The Auto Clock Set feature is set to ON at the factory. In the ON setting, the DVD+VCR looks for a channel carrying XDS (Extended Data Services) information. XDS updates the clock using the Coordinated Universal Time. The Auto Clock Feature enables the DVD+VCR to set up the clock when the DVD+VCR is turned off.

- 1** Press **MENU** and the **MAIN** menu will appear.
- 2** Use **▲/▼** to choose the **SET CLOCK** menu. Press **SELECT/ENTER** and the **SET CLOCK** menu will appear.

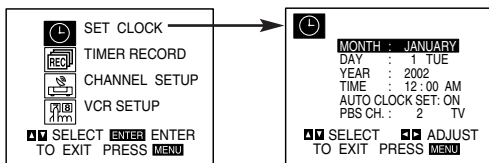

- 3** Use **▼** to choose the **AUTO CLOCK SET** option. Use **◀/▶** to choose **ON**.

The Auto Clock Set feature is set to ON at the factory. In the ON setting, the DVD+VCR looks for a channel carrying XDS (Extended Data Services) information. XDS updates the clock using the Coordinated Universal Time.

- 4** Use **▼** to choose the **PBS CH.** option. Use **◀/▶** to choose your local PBS channel.
- 5** Press **MENU** when finished.

Note

There are cases where the TV station does not send, or sends wrong date and/or time information and the DVD+VCR sets the incorrect time.

If this happens, we recommend that you set the clock manually.

Manual Clock Set

Example: July 5, 2002 ; 2:15 AM

- 1** Press **MENU** and the **MAIN** menu will appear.
- 2** Use **▲/▼** to choose the **SET CLOCK** menu. Press **SELECT/ENTER** and the **SET CLOCK** menu will appear.

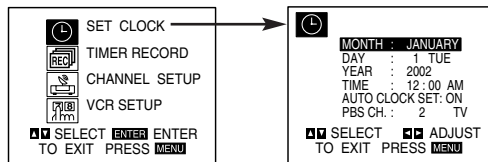

- 3** Use **◀/▶** to choose the month.
- 4** Use **▼** to choose the **DAY** option. Use **◀/▶** to choose the day. The day of the week will display automatically.
- 5** Use **▼** to choose the **YEAR** option. Use **◀/▶** to choose the year.
- 6** Use **▼** to choose the **TIME** option. Use **◀/▶** to choose the time.
- 7** Press **MENU** when finished.

Note

If setting the clock manually, "AUTO CLOCK SET" must be set to "OFF".

If set to "ON", an incorrect date and/or time will be entered again when the DVD+VCR is turned off.

Before Operation - DVD Mode



Caution:
Before using the remote control, press DVD to select the operation mode to DVD.

General Explanation

This manual gives basic instructions for operating the DVD+VCR. Some DVDs require specific operation or allow only limited operation during playback. When this occurs, the symbol  appears on the TV screen, indicating that the operation is not permitted by the DVD+VCR or is not available on the disc.

On-Screen Display

General playback status can be displayed on the TV screen. Some options can be changed on the menu.







On-screen display operation

1 Press DISPLAY during playback.

2 Press ▲ or ▼ to select an option.
The selected option will be highlighted.

3 Use ◀ or ▶ to change the setting of an option.
The number buttons can be also be used for setting numbers (e.g., title number). For some functions, press SELECT/ENTER to execute the setting.







Temporary Feedback Field Icons

-  TITLE Repeat Title
-  CHAPT Repeat Chapter
-  A B Repeat A-B
-  OFF Repeat Off
-  ■ ■ ■ Resume play from this point
-  Action prohibited or not available

Notes

- Some discs may not provide all of the features on the on-screen display example shown below.
- If no button is pressed for 10 seconds, the on-screen display disappears.

DVD

Options		Function (Use ▲/▼ to select desired option)	Selection Method
Title Number	 1/3	Shows the current title number and total number of titles, and skips to the desired title number.	◀ / ▶, or Numbers, SELECT/ENTER
Chapter Number	 1/12	Shows the current chapter number and total number of chapters, and skips to the desired chapter number.	◀ / ▶, or Numbers, SELECT/ENTER
Time search	 0:16:57	Shows the elapsed playing time, and searches the point by the elapsed time directly.	Numbers, SELECT/ENTER
Audio language and Digital Audio Output mode	 1 ENG D D D 5.1 CH	Shows the current audio soundtrack language, encoding method, and channel number, and changes the setting.	◀ / ▶
Subtitle language	 OFF	Shows the current subtitles language, and changes the setting.	◀ / ▶
Angle	 1/1	Shows the current angle number and total number of angles, and changes the angle number.	◀ / ▶

Before Operation - DVD Mode (Continued)

Initial Settings

You can set your own Personal Preferences on the player.

Initial Settings General Operation

- 1 Press SETUP.**
The setup menu appears.
- 2 Use ▲/▼ to select the desired option.**
The screen will show the current setting for the selected option, as well as alternate setting(s).
- 3 While the desired option is selected, press ►, then use ▲/▼ to select the desired setting.**
- 4 Press SELECT/ENTER to confirm your selection.**
Some options require additional steps.
- 5 Press SETUP, RETURN, or PLAY (▶) to exit the setup menu.**

Language

Disc Language **DVD**

Select a language for the disc's Menu, Audio, and Subtitle.

Original : The original language set for the disc is selected.

Other : To select another language, press number buttons to enter the corresponding 4-digit number according to the language code list on page 41. If you enter the wrong language code, press CLEAR.



Menu Language

Select a language for the setup menu. This is the menu you see when you press SETUP.



Picture

TV Aspect **DVD**

4:3 Letterbox: Select when a standard 4:3 TV is connected. Displays theatrical images with masking bars above and below the picture.

4:3 Panscan: Select when a standard 4:3 TV is connected. Displays pictures cropped to fill your TV screen. Both sides of the picture are cut off.

16:9 Wide: Select when a 16:9 wide TV is connected.

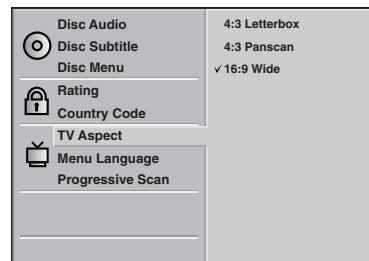

Progressive Scan **DVD**

Progressive Scan Video provides the highest quality pictures with less flickering.

If you are using the COMPONENT VIDEO OUT/ PROGRESSIVE SCAN jacks, but are connecting the DVD Player to a standard (analog) television, set Progressive Scan to Off.

If you are using the COMPONENT VIDEO OUT/ PROGRESSIVE SCAN jacks for connection to a TV or monitor that is compatible with a progressive scan signal, set Progressive Scan to On.

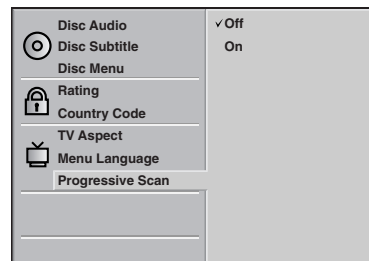

Note

- Progressive Scan only works when the VIDEO OUTPUT switch on the rear panel is set to COMPONENT/PROGRESSIVE SCAN.

Caution

Once the setting for progressive scan output is entered, an image will only be visible on a progressive scan compatible TV or monitor. If you set Progressive Scan to On in error, you must reset the unit. Press STOP (■) to stop any disc that is playing. Next, press STOP (■) again and hold it for five seconds before releasing it. The video output will be restored to the standard setting, and a picture will once again be visible on a conventional analog TV or monitor.

Before Operation - DVD Mode (Continued)

Parental Control

Rating **DVD**

Movies on DVDs may contain scenes not suitable for children. Therefore, discs may contain Parental Control information that applies to the complete disc or to certain scenes on the disc. These scenes are rated from 1 to 8, and alternatively, more suitable scenes are available for selection on some discs. Ratings are country-dependent. The Parental Control feature allows you to prevent discs from being played by your children or to have certain discs played with alternative scenes.

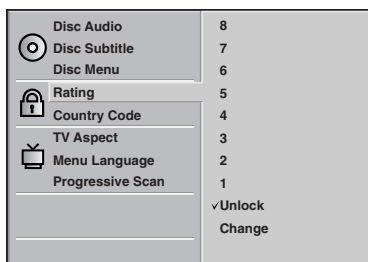

1 Select "Rating" on the Setup menu using the ▲ and ▼ buttons.

2 While "Rating" is selected, press ►.

3 When you have not entered a password yet. Enter a 4-digit password using the numbered buttons to create a personal 4-digit security password, then press SELECT/ENTER. Enter the 4-digit password again and press SELECT/ENTER to verify. **When you have already entered a password;** Enter a 4-digit password using the numbered buttons to confirm the personal 4-digit security password, then press SELECT/ENTER.

If you make a mistake before pressing SELECT/ENTER, press CLEAR and enter 4-digit security password again.

4 Select a rating from 1 to 8 using the ▲/▼ buttons. One (1) has the least playback restrictions. Eight (8) has the most playback restrictions.

Unlock: If you select Unlock, Parental Control is not active. The disc will play in full.

Ratings 1 to 8: Some discs contain scenes not suitable for children. If you set a rating for the player, all disc scenes with the same rating or lower will be played. Higher rated scenes will not be played unless an alternative scene is available on the disc. The alternative must have the same rating or a lower one. If no suitable alternative is found, playback will stop. You must enter the 4-digit password or change the rating level in order to play the disc.

5 Press SELECT/ENTER to confirm your rating selection, then press SETUP to exit the menu.

Country Code **DVD**

Enter the code of a country/area whose standards were used to rate the DVD video disc, referring to the list (See "Country Code List", page 42.).

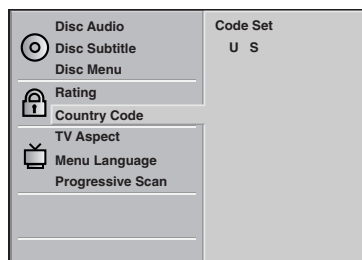

1 Select Country Code using the ▲/▼ buttons on the setup menu.

2 While Country Code is selected, press ►.

3 Follow step 3 of "Rating" on left.

4 Select the first character using the ▲/▼ buttons.

5 Shift the cursor using ◀▶ buttons and select the second character using ▲/▼ buttons.

6 Press SELECT/ENTER to confirm your country code selection, then press SETUP to exit the menu.

Note

Confirmation of the 4-digit password is necessary when the code is changed (see "Changing the 4-digit code" below).

Changing the 4-digit code

- 1 Follow Steps 1-2 as shown above to the left (Rating).
- 2 Enter the old code, then press SELECT/ENTER.
- 3 Select Change using the ▲/▼ buttons then press SELECT/ENTER.
- 4 Enter the new 4-digit code, then press SELECT/ENTER.
- 5 Enter exactly the same code a second time and verify by pressing SELECT/ENTER.
- 6 Press SETUP to exit the menu.

If you forget your 4-digit code

If you forget your password, to clear the current password, follow the procedure below.

- 1 Press SETUP to display the setup menu.
- 2 Use the Number buttons to enter the 6-digit number "210499".
The 4-digit password is cleared.
- 3 Enter a new code as shown above to the left (Rating).

Normal Playback

Preparation:

- Turn on the TV.
- Tune the TV to the DVD+VCR output channel (CH 3 or 4) or set the TV's source selector to VIDEO.
- If a direct VIDEO/AUDIO connection is made between the DVD+VCR and the TV, set the TV's source selector to VIDEO.
- Set the Output Source to VCR as shown in Selecting the Input/Output Source on page 15.

1 Insert a prerecorded video cassette.

The  indicator will light and the DVD+VCR will power-up automatically.

- Make sure that the TIMER indicator in the display window is not lighted. If it is, press **POWER** once.
- If a tape without a safety tab is inserted, the unit will start playback automatically.

2 Press **PLAY** (▶) once.

PLAY appears on the TV screen .

- It is not necessary to select the tape speed for playback. It will be automatically selected by the DVD+VCR.
- In playback, the **TV/VCR** selector switches to VCR mode automatically.

3 Press **STOP** (■) to stop playback.

STOP appears on the TV screen.

- If the tape reaches the end before **STOP** (■) is pressed, the DVD+VCR will automatically stop, rewind and eject the tape, and turn itself off.

Tracking Control

Auto Tracking

The automatic tracking function adjusts the picture to remove snow or streaks.

The AUTO TRACKING function works in the following cases:

- A tape is played back for the first time.
- Tape speed (SP, LP, EP) changes.
- Streaks or snow appear because of scratches on the tape.

Manual Tracking

If noise appears on the screen during playback, press either **CH/TRK** (▲/▼) on the remote control or **CH/PRESET** (▲/▼) on the front panel until the noise on the screen is reduced.

- In case of vertical jitter, adjust these controls very carefully.
- Tracking is automatically reset to normal when the tape is ejected or the power cord is unplugged for more than 3 seconds.

Special Effect Playback

Special effects playback notes

- Horizontal lines (noise bars) will appear on the TV screen. This is normal.
- The audio is automatically muted during special effect modes, so there is no sound during search.
- During the high-speed picture search modes, a short time is needed to stabilize tape speed when re-entering the PLAY mode. Slight interference may be observed during this time.

Search

This function lets you quickly and visually search for a desired tape section in either direction: forward and reverse.

1 Press **BACKWARD** (◀◀) or **FORWARD** (▶▶) during playback.

The DVD+VCR will be activated in the SEARCH mode.

- If the DVD+VCR is left in the SEARCH mode for more than 3 minutes, the DVD+VCR will automatically enter the PLAY mode, to protect the tape and video heads.

2 To return to playback, press **PLAY** (▶).

Still Picture and Frame-by-Frame Playback

1 Press **PAUSE/STEP** (||) during playback.

A still picture appears on the TV screen.

- If a still picture vibrates vertically, stabilize it by using **CH/TRK** (▲/▼) on the remote control.
- If the DVD+VCR is left in the STILL mode for more than 5 minutes, the DVD+VCR will automatically enter the STOP mode to protect the tape and video heads.

2 Press **PAUSE/STEP** (||) repeatedly to advance the video picture one frame at a time while viewing a still picture.

3 To return to playback, press **PLAY** (▶).

Slow Motion

1 While in still mode, press **FORWARD** (▶▶).

The tape will be played back at a speed 1/19 times slower than the normal speed.

- During slow playback, use **CH/TRK** (▲/▼) on the Remote Control to minimize noise bands.
- If slow motion mode continues for more than 30 seconds, the DVD+VCR will automatically change to playback mode.

2 To return to playback, press **PLAY** (▶).

CM SKIP (Commercial Skip)

This is useful for skipping commercials or short program segments.

1 Press **CM SKIP** in playback mode.

The tape will fast forward picture search through 30 seconds of recording.

- Skipping time can be extended by using **CM SKIP**.
- Subsequent presses result in advancing the fast forward picture search time by 30-second increments (maximum 2 minutes).

2 When the search is complete, the DVD+VCR will go into playback mode automatically.

VCR Mode Tape Recording

Normal Recording

Preparation:

- Turn on the power of both the DVD+VCR and TV.
- Tune the TV to the DVD+VCR output channel (CH 3 or 4) or set the TV's source selector to VIDEO.
- If a direct VIDEO/AUDIO connection is made between the DVD+VCR and the TV, set the TV's source selector to VIDEO.

1 Insert a video cassette with the safety tab intact.

2 Select the desired channel using CH/TRK (▲/▼).

- If you are recording from another source via audio/video input jacks (at the Rear or Front panel), select LINE1 or LINE2 by using INPUT.

3 Set the desired recording speed (SP or EP) by pressing SPEED.

- This DVD+VCR is not designed to record in LP mode.

4 Set the MTS mode as desired (See page 20, 29).

5 Press REC/ITR (●) once.

Recording will start. (The REC indicator will light in the display window.)

- If a cassette with no safety tab is loaded, the cassette will be ejected automatically.

6 Press STOP (■) to stop recording.

If the tape reaches the end before STOP (■) is pressed, the DVD+VCR will automatically stop, rewind, eject, and turn itself off.

To pause the recording

1 Press PAUSE/STEP (||) to pause the tape during recording.

The REC indicator will flash in the display window.

2 When you want to continue recording, press PAUSE/STEP (||) or press REC/ITR (●).

- After 5 minutes in pause mode, the tape will be stopped automatically to protect the tape and the video heads.

To record one TV program while watching another

1 Press TV/VCR to select the TV mode during recording.

The VCR indicator disappears.

2 Using the TV, select the channel to be viewed.

Tips

Always use PAUSE/STEP (||) for best results when making changes during recording.

For example: To change channels during recording, first press PAUSE/STEP (||) to put the unit in pause mode. Then select the desired channel on the DVD+VCR, and press PAUSE/STEP (||) again to resume recording.

Timer Recording

This DVD+VCR can be programmed to record up to 8 programs within a period of 1 year. For unattended recording, the timer needs to know the channels to be recorded and the starting and ending times.

Things to know before starting

- If you try to set the program timer before setting the clock, PLEASE SET THE CLOCK appears for a moment and then SET CLOCK menu appears on the TV screen. Set the time and date before proceeding.
- Make sure a tape is in the DVD+VCR and the safety tab is in place or the tape will be automatically ejected.

Preparation:

- Turn on the power of both the DVD+VCR and the TV.
- Be sure the TV is set to the DVD+VCR output channel (3 or 4).
- Make sure the CHANNEL SOURCE in the CHANNEL SETUP menu is set appropriately (TV or CATV).

1 Press MENU and the MAIN menu will appear.

2 Use ▲/▼ to choose the TIMER RECORD menu.

3 Press SELECT/ENTER to go to the TIMER RECORD menu.

The TIMER RECORD menu will appear.

- If all programs have already been entered, MAX NUMBER OF EVENTS SCHEDULED message will appear for a moment and then PROGRAM 1 will appear on the TV screen.

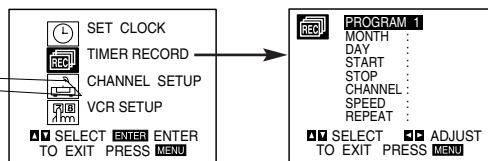

4 Use ◀/▶ to choose the PROGRAM No. (1-8).

5 Use ▼ to choose the MONTH option.

Use ◀/▶ to choose the desired month.

6 Use ▼ to choose the DAY option.

Use ◀/▶ to choose the desired day.

7 Use ▼ to choose the START option.

Use ◀/▶ to choose the desired start time.

8 Use ▼ to choose the STOP option.

Use ◀/▶ to choose the desired stop time.

9 Use ▼ to choose the CHANNEL option.

Use ◀/▶ to choose the desired channel (Channel, LINE1 or LINE2).

Cable Users: If you have CABLE TV and used Cable Box in Connecting Antenna/Cable TV to DVD+VCR (page 11), using a cable box converter, you must set the channel in this step to match the cable box output channel (usually CH 3 or 4). Change channels on the cable box instead of with the DVD+VCR.

VCR Mode Tape Recording (Continued)

- 10** Use **▼** to choose the **SPEED** option.
Use **◀/▶** to choose the desired recording speed (**AUTO**, **SP** or **EP**).
- **AUTO** mode determines how much tape is left and switches speed from **SP** to **EP**, if necessary, to complete recording the program. There will be some picture and sound distortion at the point of the speed change.

- 11** Use **▼** to choose the **REPEAT** option.
Use **◀/▶** to choose the desired repeat (**ONCE**, **WEEKLY**, or **DAILY**).
- ONCE event....**for recording up to 8 programs on a single day or over the days within a period of 1 year.
WEEKLY event....for recording up to 8 programs on a certain day of every week.
DAILY event....for recording up to 8 programs at the same time(s) Monday through Friday.

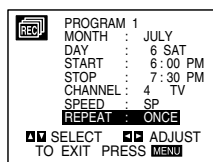

If the input data is wrong, use **▲** to select the data and correct it using **◀/▶**.

- 12** Press **MENU**, the program will be memorized by the **DVD+VCR**.
- If the program preset time is past, the **EVENT SCHEDULED IN THE PAST** message will appear on the TV screen. Return to the incorrect program and program it with the correct time.
 - If you enter a past date, the timer recording will be performed on that date of the next year.
 - Additional programs may be entered by repeating steps 1-12.

Cable Users: If your cable hookup is via a TV converter box, you can program multiple recordings only on the converter box output channel. This is because the converter determines what channel you view through your **DVD+VCR**.

- 13** Turn the **DVD+VCR** off for timer recording to take place.



If you are finished programming and you want to set the **DVD+VCR** to record the programs you have entered.

A) MAKE SURE YOU HAVE INSERTED A TAPE INTO THE DVD+VCR. B) YOU MUST TURN OFF THE DVD+VCR BEFORE IT WILL RECORD ANY TIMER PROGRAMS. (TIMER indicator lights). The **DVD+VCR** is now set to record the preset programs.



If the power fails or the **DVD+VCR** is unplugged from the AC outlet, the correct clock time and timer settings are kept in memory for approximately 3 seconds. After 3 seconds, the clock and program timer must be reset when power is restored. Reset the clock according to instructions.

Checking (Erasing) the Timer Program

Programming can be checked whenever the **DVD+VCR** is turned on.

- 1 Press **MENU** and the **MAIN** menu will appear.
- 2 Use **▲/▼** to choose the **TIMER RECORD** menu. Press **SELECT/ENTER** and the **PROGRAM** menu will appear.

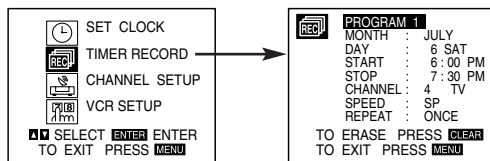

- 3 Use **◀/▶** to select a program you want to check or erase. If you want to erase the program, press **CLEAR**.
- 4 Press **MENU** to return to the TV screen.

Program Priority

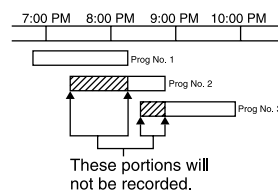

If the recording start and end times of preset programs overlap on the same day (see the example and diagram left), program number 2 will not be recorded until program number 1 is finished.

The first part of program number 2 will not be recorded. The same thing will happen to program number 3.

VCR Mode Tape Recording (Continued)

Instant Timer Recording (One-Touch Record)

Instant Timer Recording allows you to make a recording easily of a preset length without using the program timer.

Preparation:

- Turn on the power of both the DVD+VCR and the TV.
- Be sure the TV is tuned to the DVD+VCR output channel (3 or 4).
- If a direct VIDEO/AUDIO connection is made between the DVD+VCR and the TV, set the TV's source selector to VIDEO.

1 Insert a video cassette with the safety tab intact.

2 Select the desired channel using CH/TRK (▲/▼) or number (0-9).

The channel number appears on the TV screen.

- If you are recording from another source via audio/video input jacks (at the Rear or Front panel), select LINE1 (rear jacks) or LINE2 (front jacks) by using INPUT.

3 Set the desired recording speed (SP or EP) using SPEED.

The tape speed will appear on the TV screen.

4 Press REC/ITR (●) twice.

The menu as illustrated, will appear on the TV screen.

- Recording will start. (The TIMER indicator will light)

5 Press REC/ITR (●) repeatedly to select the recording time length.

At the end of the recording, the DVD+VCR will stop recording and shut off.

- During Instant Timer Recording, changing the channel on the DVD+VCR will not be possible.
- You can stop the recording by pressing STOP (■).

INSTANT TIMER RECORD (ONE-TOUCH RECORD) MENU

ONE-TOUCH RECORD	
CHANNEL	2
SPEED	SP
START LENGTH	NOW 0H30M

0H30M 9H00M → 0H00M
↑
Length Display
(each additional press of
REC/ITR (●) increases recording
time 30 minutes)

Checking the Recording Time

Press REC/ITR (●) once to check the recording time. The recalled setting will automatically return to the TV screen after 6 seconds.

To extend the Recording Time

The recording time can be extended anytime by pressing REC/ITR (●).

Subsequent presses result in advancing the recording time by 30-minute increments.

Notes

- If you press PAUSE/STEP (||) during instant timer recording, the DVD+VCR will enter the recording pause mode. Instant timer recording is cancelled.
- If the DVD+VCR is set to "0H00M", the DVD+VCR goes to normal recording mode.

Dubbing and Editing

If you wish to edit or dub your camcorder (or another VCR) recordings to this DVD+VCR, the rear (or Front) panel mounted Audio and Video (A/V) input jacks make the connections quick and easy. These direct A/V jacks will also provide better picture results than using the RF jack on the rear panel.

1 Connect the camcorder's (or another VCR's) A/V outputs to your DVD+VCR as illustrated on page 14.

2 Set the input channel "LINE2". (press INPUT twice to select LINE2.)

- If you have connected your DVD+VCR to the A/V input jacks on the rear of DVD+VCR, you should select the input channel LINE1 by using INPUT.

3 Play the tape in the camcorder (or another VCR). If you have a TV attached to your DVD+VCR, you can see the video playing.

4 When you want recording to begin, press DVD+VCR's REC/ITR (●) once to start.

Note

Before recording, please confirm the recording start position.

Copying from DVD to VCR

This unit allows you to copy the contents of a DVD to a VHS tape with a press of the COPY button.

Note

- If the DVD you are attempting to copy is copy protected, you will not be able to copy the disc. It is not permitted to copy Macrovision encoded DVDs. "COPY LOCK" is displayed in the display window.

1 Insert Disc

Insert the disc you wish to copy in the DVD deck and close the disc tray.

2 Insert a VHS Tape

Insert a blank VHS video tape into the VCR deck.

3 Press the COPY button on the unit front panel.

The DVD will go into Play mode and the VCR will go into Record mode.

- If the DVD disc menu appears, you may need to press PLAY (▶) manually to begin copying.

4 Stop the Copy Process

When the DVD is finished playing, press the VCR on the remote control and then press STOP (■) to end copying.

You must stop the Copy process manually when the DVD movie ends, or the unit may replay and record over and over again.

Note

When you stop the DVD playback during copying, the recording on VCR is stopped automatically.

VCR Mode Tape Recording Sound Setup

VHS Hi-Fi Stereo System/ MTS Broadcast

This DVD+VCR is equipped with the VHS Hi-Fi audio sound system for recording and playback. The information below gives a brief description of Hi-Fi audio and how to record and play a tape in the Hi-Fi audio mode.

Playback with Hi-Fi Stereo Audio Sound

A stereo TV with AUDIO/VIDEO input jacks or a stereo audio system is required for true stereo playback. To experience the full and rich stereo sound available with Hi-Fi recorded tapes, we recommend the connection of this unit to a home stereo audio system.

1 Set the AUDIO MODE option to HI-FI on the VCR SETUP menu .

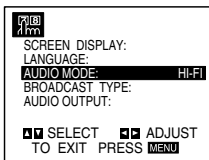

2 Set the AUDIO OUTPUT option to STEREO position.

(STEREO) POSITION: The left channel sound (L) is heard from the left speaker and the right channel sound (R) is heard from the right speaker.

(LEFT) POSITION: The left channel sound (L) is heard from both speakers.

(RIGHT) POSITION: The right channel sound (R) is heard from both speakers.

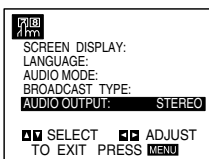

3 Insert a cassette and press PLAY (▶). Adjust volume at your stereo system.

MTS (Multi-Channel TV Sound)

This DVD+VCR will decode MTS stereo and bilingual (SAP) off-the-air broadcast sound signals. It also decodes stereo TV sound from local cable companies, as long as they operate on assigned cable frequencies and use the EIA-recommended MTS stereo/bilingual TV sound system.

Multichannel TV Sound Indicator (MTS)

Shows Onscreen as illustrated below when SELECT/ENTER is pressed.

- One or both of the indicators will light, depending on the MTS broadcast.

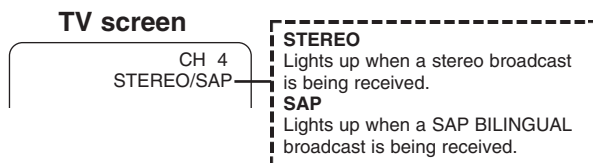

If only STEREO appears on the TV screen.

The DVD+VCR can record in stereo onto the VHS Hi-Fi audio tracks when the BROADCAST TYPE option is in the STEREO position. The DVD+VCR will also record mono audio onto the mono audio track.

If only SAP appears on the TV screen.

Set the BROADCAST TYPE option to SAP.

If STEREO/SAP appears on the TV screen

Use the BROADCAST TYPE option to select the desired recording mode (STEREO or SAP).

SAP (Second Audio Program) Recording

Some stations transmit a Second Audio Program, which is used for a second language or additional information. When the station broadcasts a Second Audio Program, follow the procedure below to record SAP.

1 Insert a video cassette with the safety tab intact.

2 Set the BROADCAST TYPE option to SAP (VCR SETUP menu).

Do this if only SAP appears on the TV screen or you know the program will use SAP.

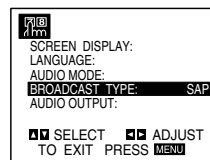

3 Set the desired recording speed (SP or EP) using SPEED.

4 Select the desired channel. SAP should appear on the TV screen.

5 Press REC/ITR (●) once

You are now recording the program you see and hear on the TV.

6 Press STOP (■) to stop recording.

Tape Counter Memory Feature

Real-Time Counter

Shows length of tape run in hours, minutes, and seconds. Press CLK/CNT to select the real-time counter display.

Every press of CLK/CNT changes the TV screen as illustrated below.

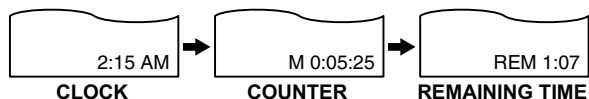

- Counter changes to "M 0:00:00" when the cassette is ejected.
- The real-time counter does not operate if nothing is recorded on the tape.
- The real-time counter will not work unless a tape is inserted.

Counter Memory Function

This is useful if there is a section of tape you want to view immediately after recording or if you want to return to the same point several times.

- 1** Begin recording or playing a tape.
- 2** Press CLK/CNT repeatedly to display the real-time counter on the TV screen.
- 3** At the point that you want to locate later, reset the real-time counter to "M 0:00:00" by pressing CLEAR.
- 4** Continue to play or record.
- 5** Press STOP (■) when recording or playback finishes.
- 6** Press BACKWARD (I◀◀).
The tape automatically stops when the tape counter returns to about "M 0:00:00".

Tape Remaining

This function allows the time of the remaining tape to be displayed during recording or playback.

Press CLK/CNT repeatedly until REM indicator displays on the TV screen during recording or playback.

Note

The remaining tape length indicator may not be displayed correctly depending on the condition of the tape and the kind of the tape (T-140, T-160, or T-210 etc)

Additional Information

- In manual recording, Timer recording, Instant Timer Recording, playback, or fast forward modes, the DVD+VCR automatically starts rewinding the tape at the end of the tape. The cassette will stop at the beginning of the tape and be ejected, and the DVD+VCR will turn itself off.
- After you have finished using the DVD+VCR, rewind, eject, and remove the cassette. Place the cassette in its protective sleeve to protect it from dust. It is not necessary to rewind the cassette before removing it, but if you do, it will be ready to play or record the next time you use it.
- Be sure the DVD+VCR Channel Selector is on the correct channel you wish to record. The channel that is being recorded can always be checked by setting the television on the DVD+VCR channel (3 or 4) and pressing the TV/VCR to turn the DVD+VCR's VCR indicator on.
- Do not attempt to hook up more than one television set to the DVD+VCR for either recording or playback.

Auto Play System

This DVD+VCR features automatic playback. Load a cassette (with the safety tab removed).

- The power turns on automatically and playback begins.
- At the end of the tape, the DVD+VCR stops, then rewinds.
- The cassette is ejected after rewinding and the unit turns itself off automatically.



Playing a DVD

Playback Setup **DVD**

- Turn on the TV and select the video input source connected to the DVD player.
- Audio system: Turn on the audio system and select the input source connected to the DVD player.
- Set the Output Source to DVD as shown in Setting the Output Source on page 15.

1 Press **OPEN/CLOSE** to open the disc tray.

2 Load your chosen disc in the tray, with the label facing up.

When a double-sided DVD is inserted, make sure the side you want to play is facing up.

3 Press **OPEN/CLOSE** to close the tray.

READING appears on the TV screen, and playback starts automatically. If playback does not start, press **PLAY**.

In some cases, the disc menu might appear instead.

Tip

If a menu screen is displayed

The menu screen may be displayed first after loading a DVD which contains a menu.

DVD

Use the **◀ ▶ ▲ ▼** buttons to select the title/chapter you want to view, then press **SELECT/ENTER** to start playback.

Press **TITLE** or **MENU** to return to the menu screen.

Notes

- If Parental Control is set and the disc is not within the Rating settings (not authorized), the 4-digit code must be entered and/or the disc must be authorized (see “Parental Control”, on page 24).
- DVDs may have a region code.
- Your player will not play discs that have a region code different from your player. The region code for this player is 1 (one).

General Features

Note

Unless stated otherwise, all operations described use the remote control. Some features may also be available on the Setup menu.

Moving to another TITLE **DVD**



When a disc has more than one title, you can move to another title as follows:

- Press **DISPLAY** when playback is stopped, then press the appropriate numbered button (0-9) to select a title number.

Moving to another CHAPTER



When a title on a disc has more than one chapter, you can move to another chapter as follows:

- Press **BACKWARD** (**◀◀**) or **FORWARD** (**▶▶**) briefly during playback to select the next chapter or to return to the beginning of the current chapter.
- Press **◀◀** twice briefly to step back to the previous chapter.
- To go directly to any chapter during DVD playback, press **DISPLAY**. Then, press **▲/▼** to select **C** (chapter). Then, enter the chapter number using the numbered buttons (0-9).

Note

For two-digit numbers, press the buttons in rapid succession.

Slow Motion **DVD**

- 1 Press **SLOW** **◀** or **▶** during playback. The player will enter SLOW mode.
- 2 Use the **SLOW** **◀** or **▶** to select the required speed: **◀** 1/16, **◀** 1/8, **◀** 1/4 or **◀** 1/2 (backward), or **▶** 1/16, **▶** 1/8, **▶** 1/4 or **▶** 1/2 (forward).
- 3 To exit slow motion mode, press **PLAY**.

DVD Mode Operation (Continued)

General Features (continued)

Still Picture and Frame-by-frame playback

DVD

- 1 Press PAUSE/STEP (II) during playback. The player will now go into PAUSE mode.
- 2 You can advance the picture frame-by-frame by pressing PAUSE/STEP (II) repeatedly on the remote control.

Search **DVD**

- 1 Press and hold BACKWARD (I◀◀) or FORWARD (▶▶I) for about two seconds during playback. The player will now go into SEARCH mode.
- 2 Press and hold BACKWARD (I◀◀) or FORWARD (▶▶I) repeatedly to select the required speed: ◀◀X2, ◀◀X4, ◀◀X16, ◀◀X100 (backward) or ▶▶X2, ▶▶X4, ▶▶X16, ▶▶X100 (forward).
- 3 To exit SEARCH mode, press PLAY (▶).

Random **Karaoke DVD**

- 1 Press RANDOM during playback or in stop mode. The unit automatically begins Random Playback and "RAND." appears on the display window.
- 2 To return to normal playback, press RANDOM until "RAND." disappears on the display window.



By pressing BACKWARD (I◀◀) or FORWARD (▶▶I) during Random playback, the unit selects another title (track) and resumes Random playback.



This function only works with DVD Karaoke discs.

Repeat **DVD**



DVD Video Discs - Repeat Chapter/Title/Off

- 1 To repeat the currently playing chapter, press REPEAT. The Repeat Chapter icon appears on the TV screen.
- 2 To repeat the title currently playing, press REPEAT a second time. The Repeat Title icon appears on the TV screen.
- 3 To exit Repeat mode, press REPEAT a third time. The Repeat Off icon appears on the TV screen.

Repeat A-B **DVD**



To repeat a sequence in a title:

- 1 Press A-B at your chosen starting point. A- appears briefly on the TV screen.
- 2 Press A-B again at your chosen end point. A-B appears briefly on the TV screen, and the repeat sequence begins ("A-B" also appears in the display window).
- 3 To cancel the sequence, press A-B.

Time Search **DVD**



The Time Search function allows you to start playing at any chosen time on the disc.

- 1 Press DISPLAY during playback. The on-screen display appears on the screen. The Time Search box shows the elapsed playing time of the current disc.
- 2 Within 10 seconds, press ▲/▼ to select the Time Search icon in the on-screen display. The "--:--:--" appears in the Time Search box.
- 3 Within 10 seconds, use the number buttons to enter the required start time. Enter hours, minutes, and seconds from left to right in the box. If you enter the wrong numbers, press CLEAR to remove the numbers you entered. Then enter the correct numbers.
- 4 Within 10 seconds, press SELECT/ENTER to confirm the start time. Playback starts from the selected time on the disc. If you enter an invalid time, playback will continue from the current point.

DVD Mode Operation (Continued)

General Features (continued)

Zoom **DVD**

The Zoom function allows you to enlarge the video image and to move through the enlarged image.

- 1 Press ZOOM during playback or still playback to activate the Zoom function.
If you press ZOOM repeatedly, the magnification level increases up to six times.
- 2 Use the ◀▶ ▲ ▼ buttons to move through the zoomed picture.
- 3 Press CLEAR to resume normal playback or return to the paused image.

Notes

- The zoom function may not work for some DVDs.
- The zoom function may not work on multi-angle scenes.

Marker Search **DVD**



You can start playback from a memorized point. Up to nine points can be memorized.

To enter a mark, follow these steps.

- 1 During disc playback, press MARKER when playback reaches the spot that you want to memorize.
The Marker icon will appear on the TV screen briefly.
- 2 Repeat step 1 to enter up to nine Marker points on a disc.

To Recall a Marked Scene

- 1 During disc playback, press SEARCH.
The MARKER SEARCH menu will appear on the screen.
- 2 Within 10 seconds, press ◀▶ to select a Marker number that you want to recall.
- 3 Press SELECT/ENTER.
Playback will start from the Marked scene.
- 4 To remove the MARKER SEARCH menu, press SEARCH.

To clear a Marked Scene

- 1 During disc playback, press SEARCH.
The MARKER SEARCH menu will appear on the screen.
- 2 Use ◀▶ to select the Marker number that you want to erase.
- 3 Press CLEAR.
The Marker number will be erased from the list.
- 4 Repeat steps 2 and 3 to erase additional Marker numbers.
- 5 To remove the MARKER SEARCH menu, press SEARCH.

Special DVD Features **DVD**

Checking the contents of DVD Video discs: Menus

DVDs may contain menus that allow you to access special features. To use the disc menu, press MENU. Then, press the appropriate number button to select an option. Or, use the ◀▶ ▲ ▼ buttons to highlight your selection, then press SELECT/ENTER.

Title Menu **DVD**

- 1 Press TITLE.
If the current title has a menu, the menu will appear on the screen. Otherwise, the disc menu may appear.
- 2 The menu can list camera angles, spoken language and subtitle options, and chapters for the title.
- 3 To remove the title menu, press TITLE again.

Disc Menu **DVD**

- 1 Press MENU.
The disc menu is displayed.
- 2 To remove the disc menu, press MENU again.

Camera Angle **DVD**



If the disc contains scenes recorded at different camera angles, you can change to a different camera angle during playback.

- Press ANGLE repeatedly during playback to select a desired angle.
The number of the current angle appears on the display.

Changing the Audio Language **DVD**



Press AUDIO repeatedly during playback to hear a different audio language or audio track.

Subtitles **DVD**



Press SUBTITLE repeatedly during playback to see the different subtitle languages.

Note

If ☹ appears, the feature is not available on the disc.

DVD Mode Audio CD Operation

Playing Audio CDs and MP3 discs

The DVD+VCR can play MP3 formatted recordings on CD-ROM, CD-R, or CD-RW discs.

Before playing MP3 recordings, read the notes on MP3 Recordings on page 36.

- 1 Insert a disc and close the tray.**
The menu appears on the TV screen.

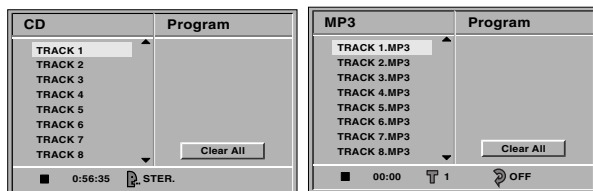

Audio CD menu

MP3 menu

- 2 Use ▲/▼ to select a track then press PLAY (▶).**
Playback starts.
During playback, the current track's elapsed playing time will appear on the display.
Playback will stop at the end of the disc.

- 3 To stop playback at any other time, press STOP (■).**

Pause **CD** **MP3**

- Press PAUSE/STEP (⏸) during playback.
- To return to playback, press PLAY (▶) or press PAUSE/STEP (⏸) again.

Moving to another Track **CD** **MP3**

- Press BACKWARD (⏮) or FORWARD (⏭) briefly during playback to go to the next track or to return to the beginning of the current track.
- Press BACKWARD (⏮) twice briefly to step back to the previous track.
- If playing an audio CD, to go directly to any track, enter the track number using the numbered buttons (0-9) during playback.

Repeat Track/All/Off **CD** **MP3**

- To repeat the track currently playing, press REPEAT. The Repeat Track icon appears on the menu screen.
- To repeat all tracks on a disc, press REPEAT a second time. The Repeat All icon appears on the menu screen.
- To cancel Repeat mode, press REPEAT a third time. The Repeat Off icon appears on the menu screen.

Search **CD**

- Press and hold BACKWARD (⏮) or FORWARD (⏭) for about two seconds during playback. The player will now go into SEARCH mode.
- Press and hold BACKWARD (⏮) or FORWARD (⏭) repeatedly to select the required speed: ⏮X2, ⏮X4, ⏮X8 (backward) or ⏭X2, ⏭X4, ⏭X8 (forward).
- Search speed and direction are indicated on the menu screen.
- To exit SEARCH mode, press PLAY (▶).

Random **CD**

- Press RANDOM during playback or when playback is stopped. The unit automatically begins Random Playback and "RAND" or "RAND." appears on the display window and menu screen.
- To return to normal playback, press RANDOM repeatedly until "RAND" or "RAND." disappears on the display window and menu screen.

Repeat A-B **CD**

To repeat a sequence.

- During disc playback, press A-B at your chosen starting point. The Repeat icon and "A-" appears on the menu screen.
- Press A-B again at your chosen end point. The Repeat icon and "A B" appears on the menu screen, and the sequence begins to play repeatedly.
- To exit the sequence and return to normal play, press A-B again. The Repeat icon and "OFF" appear on the menu screen.

Changing the Audio Channel **CD**

Press AUDIO repeatedly during playback to hear a different audio channel (STEREO, LEFT, or RIGHT).

DVD Mode Programmed Playback

Programmed Playback with Audio CD and MP3 Discs

Program allows you to store your favorite tracks for a particular disc in the player memory.

Program can contain 32 tracks (Audio CD) or 60 tracks (MP3 disc).

1 Insert the disc and close the tray.
The menu is displayed on the TV screen.

2 Press PROGRAM during playback or in the stop mode to enter the Program Edit mode.

The [E] mark will appear to the right of the word Program on the right side of the menu screen.

Note

Press PROGRAM to exit the Program Edit mode; the [E] mark will disappear.

3 Use ▲/▼ to select a track, then press SELECT/ENTER to place the selected track on the Program list.

4 Repeat step 3 to place additional tracks on the Program list.

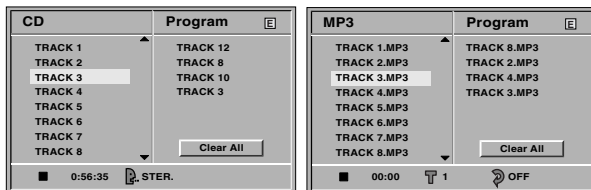

Audio CD menu

MP3 menu

5 Press ►.
The programmed track you selected last is highlighted on the program list.

6 Use ▲/▼ to select the track you want to start playing.

Press TITLE to move to the next page.
Press MENU to move to the previous page.

7 Press PLAY (▶) to start.

Playback begins in the order in which you programmed the tracks and "PROG." appears on the menu screen. Playback stops after playing the last programmed track on the program list.

Repeat Programmed Tracks

- To repeat the track currently playing, press REPEAT. The Repeat Track icon appears on the menu screen.
- To repeat all tracks on the program list, press REPEAT a second time. The Repeat All icon appears on the menu screen.
- To cancel Repeat mode, press REPEAT a third time. The Repeat Off icon appears on the menu screen.

Erasing a Track from Program List

- 1 Press PROGRAM during playback or in the stop mode to enter the Program Edit mode.
The [E] mark will appear.
- 2 Press ► to move to the Program list.
- 3 Use ▲/▼ to select the track that you wish to erase from the Program list.
- 4 Press CLEAR.
The track will be erased from the Program list.

Erasing the Complete Program List

- 1 Follow steps 1-2 of "Erasing a Track from Program List" as above.
- 2 Use ▲/▼ to select "Clear All", then press SELECT/ENTER.
The complete Program for the disc will be erased. The programs are also cleared when the disc is removed.

To resume normal playback from programmed playback

Press and hold PROGRAM for 3 seconds until "PROG." indicator disappears in the display window.

Screen Saver

The screen saver picture appears when you leave the DVD+VCR in stop mode for about five minutes. After the Screen Saver has been engaged for about five minutes, the DVD+VCR will automatically turn itself off.

Video Mode Setting **DVD**

- With certain discs, the playback picture may be flickering or Dot Crawl is shown on straight lines. That means Vertical interpolation or De-interlace is not perfectly matched with the disc. In this case, the picture quality may be improved by changing the video mode.
- To change the video mode, press and hold DISPLAY about 3 seconds during disc playback. The new video mode number selected is displayed on the TV screen. Check whether the video quality has improved. If not, repeat the above procedure until picture quality is improved.
- Video mode change sequence:
MODE1 → MODE2 → MODE3 → MODE4 →
MODE5 → MODE1
- If you turn off the power, video mode will revert to initial state (MODE1).

Notes on MP3 Discs

About MP3

- An MP3 file is audio data compressed by using MPEG1, the audio layer-3 file-coding scheme. We call files that have the “.mp3” file extension “MP3 files”.
- The player can not read an MP3 file that has a file extension other than “.mp3”.
- The player can not read a fake MP3 file that has a file extension “.mp3”.

MP3 Disc compatibility with this player is limited as follows:

1. Sampling Frequency / only at 44.1kHz
2. Bit rate/ within 32 - 320kbps
3. CD-R physical format should be “ISO 9660”
4. If you record MP3 files using the software which cannot create a FILE SYSTEM, for example “Direct-CD” etc., it is impossible to playback MP3 files. We therefore recommend that you use “Easy-CD Creator”, which creates an ISO9660 file system.
5. A single session disc requires MP3 files in the first track. If there is no MP3 file in the 1st track, it cannot playback MP3 files. If you wish to playback MP3 files, format all the data in the disc or use a new one.
6. We do not recommend using CD-RW discs. Please use finished CD-R discs only.
7. File names should be named using 8 letters or less and must incorporate the “.mp3” extension e.g. “*****.MP3”.
8. Do not use special characters such as “_?!><+*}{[@] ; V . ,” etc.
9. Total number of files on the disc should be less than 200.
10. Use 74 minute CD-R discs (650M), do not use 80 minute CD-R (700M) software.

This DVD+VCR requires discs/recordings to meet certain technical standards in order to achieve optimal playback quality. Pre-recorded DVDs are automatically set to these standards. There are many different types of recordable disc formats (including CD-R containing MP3 files).

Customers should also note that permission is required in order to download MP3 files and music from the Internet. Our company has no right to grant such permission. Permission should always be sought from the copyright owner.

Presetting Radio Stations

You can preset 30 stations for FM and AM. Before tuning, make sure that you have turned down the volume to the minimum.

- 1 Press RADIO.**
FM or AM appears in the display window and radio information appears on the TV screen.
- 2 Each time you press RADIO, you toggle between FM and AM.**
- 3 Press and hold TUNING (▲/▼) on the front panel for about two seconds until the frequency indication starts to change, then release.**
Scanning stops when the DVD Receiver tunes in a station. "STEREO" (for stereo program) appear in the display window.
- 4 Press MEMORY.**
A preset number will flash in the display window.
- 5 Use TUNING (▲/▼) on the front panel to select the preset number.**
- 6 Press MEMORY again.**
The station is stored.
- 7 Repeat steps 3 to 6 to store other stations.**

To tune in a station with a weak signal

Press TUNING (▲/▼) repeatedly in step 3 to tune in the station manually.

To clear all the memorized stations

Press and hold MEMORY for about three seconds and "MEM CLEAR" appears in the display window and then press MEMORY again, the stations are cleared.

Note

If all stations have already been entered, MEM FULL message will appear in the display window for a moment and then a preset number will flash. To change the preset number, follow the steps 5-6 as above.

Listening to the Radio

Preset radio stations in the DVD+VCR's memory first (see "Presetting radio stations" on the left side).

- 1 Press RADIO**
FM or AM appears in the display window and radio information appears on the TV screen. The last received station is tuned in.

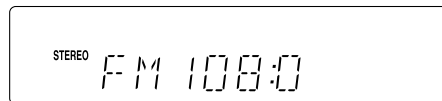

- 2 Press PRESET (▲/▼) repeatedly to select a preset station.**
Each time you press the button, the DVD+VCR tunes in one preset station at a time.
- 3 Adjust the volume by rotating VOLUME on the front panel or by pressing VOLUME + or - on the remote control repeatedly.**

To turn off the radio

Press POWER to turn the DVD+VCR off or select another function mode (DVD, VCR, or AUX).

To listen to non-preset radio stations

- Use manual or automatic tuning in step 2.
- For manual tuning, press TUNING (▲/▼) on the front panel repeatedly.
- For automatic tuning, press and hold TUNING (▲/▼) for about two seconds on the front panel.

For your reference

- **If an FM program is noisy**
Press AUDIO so that "STEREO" disappears in the display window. There will be no stereo effect, but the reception will improve. Press the button again to restore the stereo effect.
- **To improve reception**
Realign the antenna.

Troubleshooting

Check the following guide for the possible cause of a problem before contacting service.

Symptom	Cause	Solution
No power.	<ul style="list-style-type: none"> The power cord is disconnected. 	<ul style="list-style-type: none"> Plug the power cord into the wall outlet securely.
The power is on, but the DVD+VCR does not work.	<ul style="list-style-type: none"> No disc is inserted. No tape is inserted. 	<ul style="list-style-type: none"> Insert a disc or tape. (Check that the disc or tape indicator in the display window is lit.)
No picture.	<ul style="list-style-type: none"> The TV is not set to receive DVD+VCR signal output. 	<ul style="list-style-type: none"> Select the appropriate video input mode on the TV so the picture from the DVD+VCR appears on the TV screen.
	<ul style="list-style-type: none"> TV/VCR mode for DVD+VCR is set to TV. 	<ul style="list-style-type: none"> Press the TV/VCR button on the remote control repeatedly to choose VCR mode. VCR indicator light appears in the display window.
	<ul style="list-style-type: none"> The video cable is not connected securely. 	<ul style="list-style-type: none"> Connect the video cable securely.
	<ul style="list-style-type: none"> The connected TV power is turned off. 	<ul style="list-style-type: none"> Turn on the TV.
No sound.	<ul style="list-style-type: none"> The equipment connected with the audio cable is not set to receive DVD+VCR signal output. 	<ul style="list-style-type: none"> Select the correct input mode on the audio receiver so you can listen to the sound from the DVD+VCR.
	<ul style="list-style-type: none"> The audio cables are not connected securely. 	<ul style="list-style-type: none"> Connect the audio cable securely.
	<ul style="list-style-type: none"> The power of the equipment connected with the audio cable is turned off. 	<ul style="list-style-type: none"> Turn on the equipment connected with the audio cable.
	<ul style="list-style-type: none"> The audio connecting cord is damaged. 	<ul style="list-style-type: none"> Replace it with new one.
The playback picture is poor.	<ul style="list-style-type: none"> The disc is dirty. 	<ul style="list-style-type: none"> Clean the disc.
	<ul style="list-style-type: none"> Tape heads are dirty. 	<ul style="list-style-type: none"> Clean video heads.
	<ul style="list-style-type: none"> Tape is a rental or was recorded on another VCR. 	<ul style="list-style-type: none"> Use CH/TRK (▲/▼) for manual tracking adjustment while tape is playing.
The DVD+VCR does not start playback.	<ul style="list-style-type: none"> No disc is inserted. No tape is inserted. 	<ul style="list-style-type: none"> Insert a disc or tape. (Check that the disc or tape indicator in the display window is lit.)
	<ul style="list-style-type: none"> An unplayable disc is inserted. 	<ul style="list-style-type: none"> Insert a playable disc. (Check the disc type, color system, and Regional code.)
	<ul style="list-style-type: none"> The disc is placed upside down. 	<ul style="list-style-type: none"> Place the disc with the playback side down.
	<ul style="list-style-type: none"> The disc is not placed within the guide. 	<ul style="list-style-type: none"> Place the disc on the disc tray correctly inside the guide.
	<ul style="list-style-type: none"> The disc is dirty. 	<ul style="list-style-type: none"> Clean the disc.
	<ul style="list-style-type: none"> The Rating level is set. 	<ul style="list-style-type: none"> Cancel the Rating function or change the rating level.

Troubleshooting (Continued)

Symptom	Cause	Solution
Some channels are skipped over when using CH/TRK (▲/▼)	<ul style="list-style-type: none"> Those channels were deleted with the ADD/DEL CH. option. 	<ul style="list-style-type: none"> Use ADD/DEL CH. to restore channels. See "Channel Selection" on page 20.
Picture and sound of broadcasting channel are weak or missing.	<ul style="list-style-type: none"> Antenna or cables are loose. 	<ul style="list-style-type: none"> Tighten connections or replace cable.
	<ul style="list-style-type: none"> Wrong CHANNEL SOURCE option is being used. 	<ul style="list-style-type: none"> Try all CHANNEL SOURCE options. See "Channel Selection" on page 20 for details.
Camcorder image is not shown.	<ul style="list-style-type: none"> Camcorder is off. 	<ul style="list-style-type: none"> Turn camcorder on and operate properly.
Camcorder image via A/V input to DVD+VCR is not shown on TV screen.	<ul style="list-style-type: none"> DVD+VCR INPUT SELECT is not set to LINE1 or LINE2. 	<ul style="list-style-type: none"> Use INPUT to select LINE input channel (LINE1 or LINE2).
Timer recording is not possible.	<ul style="list-style-type: none"> Clock in DVD+VCR is not set to correct time. 	<ul style="list-style-type: none"> Set clock to correct time. See "Setting the Clock" on page 21.
	<ul style="list-style-type: none"> DVD+VCR is on which disables timer. 	<ul style="list-style-type: none"> Turn DVD+VCR off to enable timer. TIMER indicator light appears in the display window.
	<ul style="list-style-type: none"> Timer has been programmed incorrectly. 	<ul style="list-style-type: none"> Reprogram Timer. See "Timer Recording" on pages 26 and 27.
	<ul style="list-style-type: none"> TIMER indicator light does not appear after programming timer. 	<ul style="list-style-type: none"> Reprogram Timer and turn DVD+VCR off to enable timer.
TIMER indicator light appears after DVD+VCR is turned off.	<ul style="list-style-type: none"> DVD+VCR is in Timer Recording mode. 	<ul style="list-style-type: none"> This is the normal indication that the DVD+VCR is in TIMER mode.
Stereo Audio Record and/or Playback is not present.	<ul style="list-style-type: none"> TV is not Stereo-compatible. 	<ul style="list-style-type: none"> No action is possible.
	<ul style="list-style-type: none"> Broadcast program is not in stereo format. 	<ul style="list-style-type: none"> No action is possible.
	<ul style="list-style-type: none"> DVD+VCR A/V Out jacks are not connected to TV A/V In jacks. 	<ul style="list-style-type: none"> Make A/V connections. Stereo is available only via A/V output from DVD+VCR.
	<ul style="list-style-type: none"> DVD+VCR Audio/Video Out is not selected for viewing at the TV. 	<ul style="list-style-type: none"> Select AUX or A/V source as TV input.
	<ul style="list-style-type: none"> DVD+VCR BROADCAST TYPE mode is set to SAP or MONO. 	<ul style="list-style-type: none"> Set BROADCAST TYPE mode to STEREO. See "Using the VCR Setup Menu" on page 20.

Troubleshooting (Continued)

Symptom	Cause	Correction
Severe hum or noise is heard.	• The plugs and jacks are dirty.	• Wipe them with a cloth slightly moistened with alcohol.
	• The disc is dirty.	• Clean the disc.
	• The speakers and components are connected poorly.	• Connect the speakers and components securely.
	• The DVD+VCR is located too close to the TV.	• Move your TV away from the audio components.
Radio stations cannot be tuned in.	• The antenna is positioned or connected poorly.	• Connect the antenna securely.
		• Adjust the antennas and connect an external antenna if necessary.
	• The signal strength of the stations is too weak (when tuning in with automatic tuning).	• Tune in the station manually.
	• No stations have been preset or preset stations have been cleared (when tuning by scanning preset stations).	• Preset the stations (page 37).
No sound from DIGITAL AUDIO IN (OPTICAL).	• DVD+VCR source is not set to DIGITAL AUDIO IN (OPTICAL).	• Select OPTICAL by pressing AUX.
The remote control does not work properly.	• The remote control is not pointed at the remote sensor of the DVD+VCR.	• Point the remote control at the remote sensor of the DVD+VCR.
	• The remote control is too far from the DVD+VCR.	• Operate the remote control within 23 ft (7 m).
	• There is an obstacle in the path of the remote control and the DVD+VCR.	• Remove the obstacle.
	• The batteries in the remote control are exhausted.	• Replace the batteries with new ones.
	• This remote control uses same buttons for VCR and DVD (ex. PLAY).	• When using a VCR, first press the VCR button. When using a DVD, first press the DVD button.

Moisture Condensation

Moisture condensation can occur:	In locations where moisture condensation may occur:
<ul style="list-style-type: none"> • When the DVD+VCR is moved from a cold place to a warm place. • Under extremely humid conditions. 	<ul style="list-style-type: none"> • Keep the DVD+VCR plugged into an AC power outlet with POWER On. This will help prevent condensation. • When condensation has occurred, wait a few hours for the DVD+VCR to dry before using it.

Language Code List

Enter the appropriate code number for the initial settings “Disc Audio”, “Disc Subtitle” and/or “Disc Menu” (See page 23).

Code	Language	Code	Language	Code	Language	Code	Language
6566	Abkhazian	7074	Fiji	7678	Lingala	8373	Singhalese
6565	Afar	7073	Finnish	7684	Lithuanian	8375	Slovak
6570	Afrikaans	7082	French	7775	Macedonian	8376	Slovenian
8381	Albanian	7089	Frisian	7771	Malagasy	8379	Somali
6577	Amharic	7176	Galician	7783	Malay	6983	Spanish
6582	Arabic	7565	Georgian	7776	Malayalam	8385	Sudanese
7289	Armenian	6869	German	7784	Maltese	8387	Swahili
6583	Assamese	6976	Greek	7773	Maori	8386	Swedish
6588	Aymara	7576	Greenlandic	7782	Marathi	8476	Tagalog
6590	Azerbaijani	7178	Guarani	7779	Moldavian	8471	Tajik
6665	Bashkir	7185	Gujarati	7778	Mongolian	8465	Tamil
6985	Basque	7265	Hausa	7865	Nauru	8484	Tatar
6678	Bengali; Bangla	7387	Hebrew	7869	Nepali	8469	Telugu
6890	Bhutani	7273	Hindi	7879	Norwegian	8472	Thai
6672	Bihari	7285	Hungarian	7982	Oriya	6679	Tibetan
6682	Breton	7383	Icelandic	8065	Panjabi	8473	Tigrinya
6671	Bulgarian	7378	Indonesian	8083	Pashto, Pushto	8479	Tonga
7789	Burmese	7365	Interlingua	7065	Persian	8482	Turkish
6669	Byelorussian	7165	Irish	8076	Polish	8475	Turkmen
7577	Cambodian	7384	Italian	8084	Portuguese	8487	Twi
6765	Catalan	7465	Japanese	8185	Quechua	8575	Ukrainian
9072	Chinese	7487	Javanese	8277	Rhaeto-Romance	8582	Urdu
6779	Corsican	7578	Kannada	8279	Romanian	8590	Uzbek
7282	Croatian	7583	Kashmiri	8285	Russian	8673	Vietnamese
6783	Czech	7575	Kazakh	8377	Samoan	8679	Volapük
6865	Danish	7589	Kirghiz	8365	Sanskrit	6789	Welsh
7876	Dutch	7579	Korean	7168	Scots Gaelic	8779	Wolof
6978	English	7585	Kurdish	8382	Serbian	8872	Xhosa
6979	Esperanto	7679	Laothian	8372	Serbo-Croatian	7473	Yiddish
6984	Estonian	7665	Latin	8378	Shona	8979	Yoruba
7079	Faeroese	7686	Latvian, Lettish	8368	Sindhi	9085	Zulu

Country Code List

Enter the appropriate code number for the initial setting "Country Code" (See page 24).

Code	Country	Code	Country	Code	Country	Code	Country
AD	Andorra	ER	Eritrea	LC	Saint Lucia	SC	Seychelles
AE	United Arab Emirates	ES	Spain	LI	Liechtenstein	SD	Sudan
AF	Afghanistan	ET	Ethiopia	LK	Sri Lanka	SE	Sweden
AG	Antigua and Barbuda	FI	Finland	LR	Liberia	SG	Singapore
AI	Anguilla	FJ	Fiji	LS	Lesotho	SH	Saint Helena
AL	Albania	FK	Falkland Islands	LT	Lithuania	SI	Slovenia
AM	Armenia	FM	Micronesia	LU	Luxembourg	SJ	Svalbard and Jan Mayen Islands
AN	Netherlands Antilles	FO	Faroe Islands	LV	Latvia	SK	Slovak Republic
AO	Angola	FR	France	LY	Libya	SL	Sierra Leone
AQ	Antarctica	FX	France (European Territory)	MA	Morocco	SM	San Marino
AR	Argentina	GA	Gabon	MC	Monaco	SN	Senegal
AS	American Samoa	GB	Great Britain	MD	Moldavia	SO	Somalia
AT	Austria	GD	Grenada	MG	Madagascar	SR	Suriname
AU	Australia	GE	Georgia	MH	Marshall Islands	ST	Saint Tome and Principe
AW	Aruba	GF	French Guyana	MK	Macedonia	SU	Former USSR
AZ	Azerbaijan	GH	Ghana	ML	Mali	SV	El Salvador
BA	Bosnia-Herzegovina	GI	Gibraltar	MM	Myanmar	SY	Syria
BB	Barbados	GL	Greenland	MN	Mongolia	SZ	Swaziland
BD	Bangladesh	GM	Gambia	MO	Macau	TC	Turks and Caicos Islands
BE	Belgium	GN	Guinea	MP	Northern Mariana Islands	TD	Chad
BF	Burkina Faso	GP	Guadeloupe (French)	MQ	Martinique (French)	TF	French Southern Territories
BG	Bulgaria	GQ	Equatorial Guinea	MR	Mauritania	TG	Togo
BH	Bahrain	GR	Greece	MS	Montserrat	TH	Thailand
BI	Burundi	GS	S. Georgia & S. Sandwich Isls.	MT	Malta	TJ	Tadjikistan
BJ	Benin	GT	Guatemala	MU	Mauritius	TK	Tokelau
BM	Bermuda	GU	Guam (USA)	MV	Maldives	TM	Turkmenistan
BN	Brunei Darussalam	GW	Guinea Bissau	MW	Malawi	TN	Tunisia
BO	Bolivia	GY	Guyana	MX	Mexico	TO	Tonga
BR	Brazil	HK	Hong Kong	MY	Malaysia	TP	East Timor
BS	Bahamas	HM	Heard and McDonald Islands	MZ	Mozambique	TR	Turkey
BT	Bhutan	HN	Honduras	NA	Namibia	TT	Trinidad and Tobago
BV	Bouvet Island	HR	Croatia	NC	New Caledonia (French)	TV	Tuvalu
BW	Botswana	HT	Haiti	NE	Niger	TW	Taiwan
BY	Belarus	HU	Hungary	NF	Norfolk Island	TZ	Tanzania
BZ	Belize	ID	Indonesia	NG	Nigeria	UA	Ukraine
CA	Canada	IE	Ireland	NI	Nicaragua	UG	Uganda
CC	Cocos (Keeling) Islands	IL	Israel	NL	Netherlands	UK	United Kingdom
CF	Central African Republic	IN	India	NO	Norway	UM	USA Minor Outlying Islands
CG	Congo	IO	British Indian Ocean Territory	NP	Nepal	US	United States
CH	Switzerland	IQ	Iraq	NR	Nauru	UY	Uruguay
CI	Ivory Coast	IR	Iran	NU	Niue	UZ	Uzbekistan
CK	Cook Islands	IS	Iceland	NZ	New Zealand	VA	Vatican City State
CL	Chile	IT	Italy	OM	Oman	VC	Saint Vincent & Grenadines
CM	Cameroon	JM	Jamaica	PA	Panama	VE	Venezuela
CN	China	JO	Jordan	PE	Peru	VG	Virgin Islands (British)
CO	Colombia	KE	Kenya	PF	Polynesia (French)	VI	Virgin Islands (USA)
CR	Costa Rica	KG	Kyrgyzstan	PG	Papua New Guinea	VN	Vietnam
CS	Former Czechoslovakia	KH	Cambodia	PH	Philippines	VU	Vanuatu
CU	Cuba	KI	Kiribati	PK	Pakistan	WF	Wallis and Futuna Islands
CV	Cape Verde	KM	Comoros	PL	Poland	WS	Samoa
CX	Christmas Island	KN	Saint Kitts & Nevis Anguilla	PM	Saint Pierre and Miquelon	YE	Yemen
CY	Cyprus	KP	North Korea	PN	Pitcairn Island	YT	Mayotte
CZ	Czech Republic	KR	South Korea	PR	Puerto Rico	YU	Yugoslavia
DE	Germany	KW	Kuwait	PT	Portugal	ZA	South Africa
DJ	Djibouti	KY	Cayman Islands	PW	Palau	ZM	Zambia
DK	Denmark	KZ	Kazakhstan	PY	Paraguay	ZR	Zaire
DM	Dominica	LA	Laos	QA	Qatar	ZW	Zimbabwe
DO	Dominican Republic	LB	Lebanon	RE	Reunion (French)		
DZ	Algeria			RO	Romania		
EC	Ecuador			RU	Russian Federation		
EE	Estonia			RW	Rwanda		
EG	Egypt			SA	Saudi Arabia		
EH	Western Sahara			SB	Solomon Islands		

Specifications

General

Power requirements	AC 120V, 60 Hz
Power consumption	80W
Dimensions (approx.)	430 X 97.5 X 360 mm (16.9 x 3.9 x 14.2 inches) (w x h x d)
Mass (approx.)	7 kg (15.4 lbs)
Operating temperature	5°C to 35°C (41°F to 95°F)
Operating humidity	5 % to 90 %
Signal system	NTSC

Inputs

ANTENNA IN	Antenna or CATV input, 75 ohms
VCR VIDEO IN	1 Vp-p 75 ohms, sync negative, RCA jack x 1
VCR AUDIO IN	-6.0 dBm more than 47 kohms, RCA jack (L, R) x 1
FM ANTENNA IN	FM antenna input, 300 ohms
AM ANTENNA IN	AM antenna input, 300 ohms
DIGITAL AUDIO IN	5 V (p-p), 75 Ω, Optical connector x 1

Outputs

VIDEO OUT	1 Vp-p 75 ohms, sync negative
S-VIDEO OUT	(Y) 1.0 V (p-p), 75 ohms, negative sync, Mini DIN 4-pin x 1 (C) 0.286 V (p-p) 75 ohms
COMPONENT VIDEO OUT (PROGRESSIVE SCAN)	(Y) 1.0 V (p-p), 75 ohms, negative sync, RCA jack x 1 (Pb)/(Pr) 0.7 V (p-p), 75 ohms, RCA jack x 2
Audio output (analog audio)	1.1 Vrms (1 KHz, 0 dB), 330 ohms, RCA jack (L, R) x 1
RF OUT	Channel 3 or 4 (Switchable)

VCR Specifications

Head system	Four head helical scan azimuth system
Timer	12-hour display type with AM, FM
Tape speed	SP: 33.35 mm/sec, LP: 16.67 mm/sec, EP: 11.12 mm/sec
Tape width	12.7 mm
Maximum recording time	SP: 2 HOURS (T-120), EP: 6 HOURS (T-120)/8 HOURS (T-160)
Rewind time	About 150 seconds (T-120)
Antenna	75 ohms (VHF/UHF)
Channel coverage	VHF: 2-13, UHF: 14-69, CATV: 1-125 (4A, A-W, W+1 - W+84, A-5 - A-1)
Frequency range	20Hz to 20kHz
Signal-to-noise ratio	More than 43dB
Dynamic range	More than 85 dB (AUDIO OUT jacks)
Channel separation	More than 55 dB (AUDIO OUT jacks)

DVD Specifications

Laser system	Semiconductor laser, wavelength 650 nm
Frequency response	DVD (PCM 48 kHz): 8 Hz to 22 kHz, CD: 8 Hz to 20 kHz
Signal-to-noise ratio	More than 75dB (AUDIO OUT jacks)
Harmonic distortion	Less than 0.4%
Dynamic range	More than 85 dB (AUDIO OUT jacks)

Specifications (Continued)

FM Tuner

Tuning Range	87.5 - 108 MHz
Intermediate Frequency	10.7 MHz
Signal-to-Noise Ratio	60 dB
Frequency Response	150 - 10,000 Hz

AM Tuner

Tuning Range	530 - 1,720 kHz
Intermediate Frequency	450 kHz

Amplifier

Stereo mode	50W + 50W (8 Ω at 1 kHz, THD 10 %)
Surround mode	Front: 50W + 50W (THD 10 %) Center*: 50W Surround*: 50W + 50W (8Ω at 1 kHz, THD 10 %) Subwoofer*: 100W (4Ω at 30 Hz, THD 10 %)
Inputs	*Depending on the sound mode settings and the source, there may be no sound output. LINE 1, LINE 2, OPTICAL IN

Speakers

	Satellite Speaker	Passive Subwoofer
Type	2 Way 2 Speaker	1 Way 1 Speaker
Impedance	8 Ω	4 Ω
Frequency Response	110 - 40,000 Hz	40 - 1,500 Hz
Sound Pressure Level	83 dB/W (1m)	82 dB/W (1m)
Rated Input Power	50W	100 W
Max. Input Power	100 W	200 W
Net Dimensions (W x H x D)	100 x 147 x 127.5 mm (3.9 x 5.8 x 5.0 inches)	200 x 425 x 381 mm (7.9 x 16.7 x 15 inches)
Net Weight	0.92 kg (2.0 lbs)	7.06kg (15.6 lbs)

Accessory:

S-Video cable	1
Video cable	1
Audio cable	1
RF 75-ohm Coaxial Cable	1
Speakers	6
Speaker cables	5
AM loop antenna	1
FM antenna	1
Remote control	1
Batteries	2

- Design and specifications are subject to change without notice.

Manufactured under license from Dolby Laboratories. Dolby and the double-D symbol are trademarks of Dolby Laboratories. Confidential unpublished works. Copyright 1992-1997 Dolby Laboratories. All rights reserved.

DTS and DTS Digital Surround are registered trademarks of Digital Theater Systems, Inc.

ZENITH ELECTRONICS CORPORATION
DVD/VCR/Radio Combination Home Theater System Limited Warranty - USA



Zenith will repair or replace your product, at Zenith's option, if it proves to be defective in material or workmanship under normal use, during the warranty period ("Warranty Period") listed below, effective from the date ("Date of Purchase") of original consumer purchase of the product. This limited warranty is good only to the original purchaser of the product and effective only when used in the United States, excluding U.S. Territories.

WARRANTY PERIOD: LABOR: 90 days from the Date of Purchase. Parts: One year from the Date of Purchase. * Parts replaced are warranted for the remaining portion of the original warranty period.	HOW SERVICE IS HANDLED: Carry-in Service: Please retain dealer's dated bill of sale or delivery ticket as evidence of the Date of Purchase for proof of warranty, and submit a copy of the bill of sale to the service person at the time warranty service is provided. Please call 1-877-9Zenith (1-877-993-6484) to locate your nearest Zenith Authorized Service Center.
---	--

THIS WARRANTY IS IN LIEU OF ANY OTHER WARRANTIES, EXPRESS OR IMPLIED, INCLUDING WITHOUT LIMITATION, ANY WARRANTY OF MERCHANTABILITY OR FITNESS FOR A PARTICULAR PURPOSE. TO THE EXTENT ANY IMPLIED WARRANTY IS REQUIRED BY LAW, IT IS LIMITED IN DURATION TO THE EXPRESS WARRANTY PERIOD ABOVE. ZENITH WILL NOT BE LIABLE FOR ANY INCIDENTAL, CONSEQUENTIAL, INDIRECT, SPECIAL OR PUNITIVE DAMAGES OF ANY NATURE, EVEN IF ADVISED OF THE POSSIBILITY OF SUCH DAMAGES, INCLUDING WITHOUT LIMITATION, LOST REVENUES OR PROFITS, LOST OR CORRUPTED PROGRAMMING OR DATA, OR ANY OTHER DAMAGE WHETHER BASED IN CONTRACT, TORT OR OTHERWISE.

Some states do not allow the exclusion or limitation of incidental or consequential damages or limitation on how long an implied warranty lasts, so the above exclusion or limitation may not apply to you. This warranty gives you specific legal rights and you may also have other rights that may vary from state to state.

THIS LIMITED WARRANTY DOES NOT APPLY TO:

1. Damages or operating problems that result from shipping, installation, adjustment of user controls, calibration, maintenance or failure to maintain, or separate system components; and
2. Damages or operating problems that result from normal wear and tear, misuse, abuse, operation outside environmental specifications or contrary to the requirements or precautions in the Operating Guide, accident, lightning strikes or other natural causes, unauthorized modification or alteration, incorrect electrical current or voltage, signal reception or input, software not licensed directly by Zenith, software errors that do not disable functionality, operating and software protocols adopted after date of manufacture or for outside the US, institutional or commercial use, or other causes not arising out of defect in material or workmanship.
3. **Therefore, the cost of repair or replacement of such a defective product shall be borne by the consumer.**

CUSTOMER INTER-ACTIVE CENTER NUMBERS:

For nearest Authorized Service Center, Where to buy, Product Assistance, or Customer Assistance	Call 1-877-9Zenith (1-877-993-6484) (Monday – Friday, 7 AM ~ 8 PM CT; and Saturday, 8 AM ~ 5 PM CT) and select appropriate option from the menu. Or visit our website at http://www.zenithservice.com
--	--